

**K**  
**RAIN**®



**Down here.  
Doing.  
It.  
Right.**

# Table of Contents

<b>OUR GRASS ROOTS</b>	01		
<b>ROTORS</b>	02	<b>ELECTRIC VALVES</b>	48
Rotor Comparison Chart	03	Valve Comparison Chart	49
MiniPro®	04	ProSeries 100 Valves	50
RPS™ 50	06	ProSeries 150 Valves	52
RPS™ 75	07	ProSeries 200 Valves	54
RPS™ 75i	10	Valve Accessories	55
RPS™ Select	14	<b>CONTROLLERS</b>	56
ProPlus®	16	Controller Comparison Chart	57
SuperPro®	18	SiteMaster	58
ProSport®	22	PRO EX 2.0	60
Rotor Accessories	24	PRO-LC	63
<b>SPRAYS</b>	26	RPS™ 46	64
Spray Body Comparison Chart	27	K-Rain BLUE®	65
Pro-S™	28	Rain Sensor	66
NP Sprays	30	Controller Accessories	67
K-Sprays	31	<b>PUMP START RELAYS</b>	68
Spray Accessories	32	<b>SINGLE STATION CONTROLLER</b>	69
<b>NOZZLES</b>	34	<b>INDEXING VALVES</b>	
Nozzle Comparison Chart	35	4000 Series Indexing Valve	70
Rotary Nozzle Series	36	6000 Series Indexing Valve	71
Fully Adjustable Rotary Nozzles	38	<b>RECLAIMED WATER (RCW)</b>	72
KVF Nozzles	40	Custom Products	74
KV Nozzles	42	Premier Contractor Program	75
Fixed Pattern Nozzles	44	Design Resources	76
<b>DRIP, BUBBLERS</b>		Charts	77
Drip Irrigation	46		
Bubblers	47		

The best products in the industry deserve the best warranty in the industry.

So do you.

K-Rain products are designed to stand the test of time. But should something happen, we've got you covered with our industry-leading 3/7 Warranty. **It's our best warranty ever, and one else offers anything better.**

There's no trickery, no hidden fine print. It's honest and fair, plain and simple. Electronics, Rotary Nozzles and Drip have a 3-year warranty. Rotors, sprays, valves and everything else has a 7-year warranty.

That's not just a huge added value, that's a whole lot of peace of mind, right there.

### 3-Year Warranty:

Electronics, rotary nozzles and drip

### 7-year Warranty:

Everything else

See page 88 for more information.





**It's about hard work and teamwork and a relentless spirit.  
It's about fifty plus years of every little thing mattering.**

### **It's not rocket science. Or is it?**

Our story begins with a rocket scientist. A real rocket scientist. With a background in chemical engineering and a stint in the Army Artillery Corps Guided Missile School, Carl Kah Jr. helped develop early reusable rocket technology at Pratt & Whitney. That's NASA rocket technology (still in use today mind you).

With a natural born instinct for invention, Carl turned his attention to his own landscape irrigation system and thought, I can make it better. Call it: When science meets grass roots greatness. From the lathe in his garage, he designed and machined a valve that cycled zone-to-zone and eliminated the need for multiple valves. That creative inventiveness, or inventive creativity, led to patent number one in 1966.

With acres of ideas for greening up any size space, in 1970 Carl invented and patented a device he called Modulated Pressure Control. It allowed for the control of the entire irrigation system of a golf course without wires or tubes. The sale of that patent was the green light to incorporating K-Rain Manufacturing in 1972.

### **Cultivating growth**

Helping to grow the business from the ground up was son, Chip, who joined the company in 1986. Committed to engineering products that are reliable and eco-conscious, Chip led the development and growth of indexing valves for the wastewater disposal industry.

In 1991, Carl and Chip, always innovating, introduced the first of many patented gear drive rotors. Four years later, K-Rain augmented the professional line by expanding its products into the retail market - taking the business to the next level.

Joining the burgeoning business that same year were Carl's two daughters, Gretchen and Deborah. Gretchen would lead growth in the west coast sales division. Deborah, an attorney, would be managing intellectual property and human resources. And in 2016, Chip's two sons, Christopher and Trevor, joined K-Rain making it a 3rd generation company.

### **Green and Growing the Industry**

Look across the industry and you'll find a little bit of K-Rain innovation sprinkled into the competitive set. K-Rain holds over 100 patents specific to irrigation including the three-spring reversing mechanism still used today in most gear-driven sprinklers.

Engineering the hardest-working irrigation products in the world is our heritage and our mission. Our commitment to quality is reflected in an ISO 9001 quality certification - the standard for manufacturing and process control.

We're also environmentally conscious about the materials we select and the products we produce. Sustainability is in our DNA. That's why we're an industry leader with a full range of products for reclaimed/recycled water.

Over 400 men and women make up the K-Rain dream team, serving customers in the United States and more than 60 countries worldwide.

# rotors



## Rotor Comparison Chart

From small landscapes to sports stadiums, K-Rain has a rotor for every landscape. Designed and built to provide year after year high performance and low maintenance, K-Rain rotors deliver outstanding coverage on any terrain. Enjoy a comprehensive range of innovative features and exceptional functionality.

	MiniPro	RPS50	RPS75	RPS75i	RPS Select	ProPlus	SuperPro	ProSport
<b>Specifications</b>								
Inlet Size	1/2"	1/2"	3/4"	3/4"	3/4"	3/4"	3/4"	1"
Radius	18'-33'	18'-33'	22'-51'	26'-48'	33'-46'	22'-50'	26'-46'	43'-77'
Flow Range (GPM)	0.8-3.8	0.8-3.8	0.7-8.3	0.9-9.7	1.3-6.8	0.5-10.0	0.8-11.1	5.1-32.5
<b>Features</b>								
Pressure Rating (PSI)	20-70	20-70	20-70	20-70	20-70	20-70	20-70	40-90
Nozzle Trajectory	25°	25°	26°	26°	24°	26°	26°	26°
Pre-installed Nozzles	#1.5	#1.5	#3.0	#2.5	4 built-in selectable	#2.5	#2.5	#10
Low Angle Nozzle Choices			•	•		•	•	
Non-Strippable Drive (arc memory clutch)						•	•	•
Arc Adjustment Range	40°-360°	40°-360°	40°-360°	40°-360°	40°-360°	40° to cont. 360°	40° to cont. 360°	40° to cont. 360°
Top Arc Set Indication	•				•	•	•	•
Intelligent Flow Technology®				•			•	
Reclaimed Water Available	•		•	•	•	•	•	•
Stainless Steel Available			•	•				•
Optional or Factory Installed CV	•	•	•	•	•	•	•	Standard
Pressure Regulation Option			•	•				
Warranty	7 years	7 years	7 years	7 years	7 years	7 years	7 years	7 years

# MiniPro®

Perfect for small lawn and landscape areas.

## Features

- Revolutionary Patented Top Arc Set – Simplified arc set allows for wet or dry adjustment in seconds
- 1/2" Inlet – Replaces all standard mini rotors and pop-up sprays
- Adjustable to 360° – Full range of adjustment from 40° to 360°
- Patented Top Arc Set Degree Markings – Clearly indicates the current watering pattern and simplifies arc set adjustment
- Time Proven Patented Reversing Mechanism – Assures continuous reverse and return...over a 35 year history
- Rubber Cover – Seals out dirt and increases product durability
- Optional Check Valve – Prevents low head drainage

## Specifications

- Arc Adjustment Range: 40° – 360°
- Flow Range: 0.8 – 3.8 GPM (3,0 – 14,4 LPM)
- Pressure Rating: 20 – 70 PSI (1,4 – 4,8 bar)
- Precipitation Rate: .26 – .60 in/hr (6,6 – 15,2 mm/hr) (depending on spacing and nozzle used)
- Recommended Spacing: 17' – 28' (5,2 – 8,5 m)
- Radius: 18' – 33' (5,5 – 10,1 m)
- Nozzle Trajectory: 25°

## Easy Arc Setting

Arc Selection: 40° to 360°  
Adjust from left start



## Model

**13003** 4" (10,2 cm) MiniPro®

**13006** 6" (15,2 cm) MiniPro®

**13012** 12" (30,5 cm) MiniPro®

## Accessories

See page 24-25

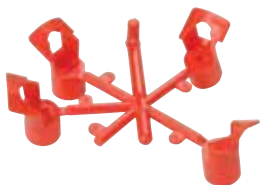

## Fast Facts

All	Inlet: 1/2" (1,3 cm) female thread NPT
4"	Retracted height: 6" (15,2 cm) Riser height: 4" (10,2 cm)
6"	Retracted height: 8 3/8" (21,3 cm) Riser height: 6" (15,2 cm)
12"	Retracted height: 15 1/4" (38,7 cm) Riser height: 12" (30,5 cm)



## Performance Data

NOZZLE	PRESSURE PSI	RADIUS Feet	FLOW GPM	PRECIP in/hr	
				■	▲
#0.75	30	18	0.8	.45	.55
	40	19	0.8	.43	.49
	50	20	0.9	.43	.50
#1.0	30	26	0.9	.26	.30
	40	27	1.2	.32	.37
	50	27	1.3	.34	.40
#1.5 Pre- installed	30	27	1.5	.40	.46
	40	27	1.8	.48	.55
	50	28	2.0	.49	.57
#2.0	30	29	2.0	.46	.53
	40	30	2.3	.49	.57
	50	31	2.7	.54	.62
#3.0	30	32	3.0	.56	.65
	40	33	3.4	.60	.69
	50	33	3.8	.67	.78

## Performance Data, Metric

NOZZLE	PRESSURE Bar	RADIUS Meters	FLOW L/M	PRECIP mm/hr	
				■	▲
#0.75	2,1	5,5	3,0	11	14
	2,8	5,8	3,0	11	12
	3,4	6,1	3,4	11	12
#1.0	2,1	7,9	3,4	7	8
	2,8	8,2	4,5	8	9
	3,4	8,2	4,9	9	10
#1.5 Pre- installed	2,1	8,2	5,7	10	12
	2,8	8,2	6,8	12	14
	3,4	8,5	7,6	12	14
#2.0	2,1	8,8	7,6	12	13
	2,8	9,1	8,7	12	14
	3,4	9,4	10,2	14	16
#3.0	2,1	9,8	11,4	14	17
	2,8	10,1	12,9	15	18
	3,4	10,1	14,4	17	20

\*All precipitation rates calculated for 180° operation.  
For the precipitation rate for a 360° sprinkler, divide by 2.

## How to Specify with Options

MODEL	OPTION
13003	-CV Check valve
13006	-NN No nozzle
13012	-RCW Reclaimed water use

Examples: 13003-NN, 13006-RCW-CV



# RPS™ 50

Designed for smaller landscape areas.

## Features

- Right Position Start
- Patented Reversing Mechanism – Continuous reverse and return
- Ideal for use in tandem with larger rotors
- Rubber Cover – Seals out dirt and increases product durability
- Comes with 5 Nozzles for system flexibility
- Optional Check Valve – Prevents low head drainage

## Specifications

- Arc Adjustment Range: 40° – 360°
- Flow Range: .8 – 3.8 GPM (3,0 – 14,4 LPM)
- Pressure Rating: 20 – 70 PSI (1,4 – 4,8 bar)
- Precipitation Rate: .26 – .60 in/hr (6,6 – 15,2 mm/hr)  
(depending on spacing and nozzle used)
- Recommended Spacing: 17' – 28' (5,2 – 8,5 m)
- Radius: 18' – 33' (5,5 – 10,1 m)
- Nozzle Trajectory: 25°

## Easy Arc Setting

Arc Selection: 40° to 360°  
Adjust from right start



## Model

RPS50 RPS™ 50

## Accessories

See page 24-25



## Fast Facts

Inlet: 1/2" (1,3 cm) female thread NPT

Retracted height: 6" (15,2 cm)

Riser height: 4" (10,2 cm)

## How to Specify with Options

MODEL	OPTION
RPS50	-CV Check valve -RCW Reclaimed Water Use

Example: RPS50-CV



## Performance Data

NOZZLE	PRESSURE PSI	RADIUS Feet	FLOW GPM	PRECIP in/hr	
				■	▲
#0.75	30	18	0.8	.45	.55
	40	19	0.8	.43	.49
	50	20	0.9	.43	.50
#1.0	30	26	0.9	.26	.30
	40	27	1.2	.32	.37
	50	27	1.3	.34	.40
#1.5 Pre- installed	30	27	1.5	.40	.46
	40	27	1.8	.48	.55
	50	28	2.0	.49	.57
#2.0	30	29	2.0	.46	.53
	40	30	2.3	.49	.57
	50	31	2.7	.54	.62
#3.0	30	32	3.0	.56	.65
	40	33	3.4	.60	.69
	50	33	3.8	.67	.78

## Performance Data, Metric

NOZZLE	PRESSURE Bar	RADIUS Meters	FLOW L/M	PRECIP mm/hr	
				■	▲
#0.75	2,1	5,5	3,0	11	14
	2,8	5,8	3,0	11	12
	3,4	6,1	3,4	11	12
#1.0	2,1	7,9	3,4	7	8
	2,8	8,2	4,5	8	9
	3,4	8,2	4,9	9	10
#1.5 Pre- installed	2,1	8,2	5,7	10	12
	2,8	8,2	6,8	12	14
	3,4	8,5	7,6	12	14
#2.0	2,1	8,8	7,6	12	13
	2,8	9,1	8,7	12	14
	3,4	9,4	10,2	14	16
#3.0	2,1	9,8	11,4	14	17
	2,8	10,1	12,9	15	18
	3,4	10,1	14,4	17	20

\*All precipitation rates calculated for 180° operation.  
For the precipitation rate for a 360° sprinkler, divide by 2.



Sets the standard for 3/4" gear-driven rotors.

[www.krain.com](http://www.krain.com)

## Features

- Right Position Start
- Patented reversing mechanism feature ensures continuous reverse and return
- Full and Part Circle Rotation – Provides a full range of adjustment from 40° to 360°
- Non-flushing Wiper Seal – Reduces leaks caused by debris trapped under seal
- 3/4" (1,9 cm) Inlet – Replaces all standard rotors
- Ideal for Low Flow Applications
- Rubber Cover – Seals out dirt and increases durability
- Wide Selection of Nozzles – Including standard and low angle for flexibility in system design
- Includes 5 Free Check Valve Assemblies Per Box
- Universal Riser Assembly – Fits into existing Hunter® PGP® and PGP® Ultra cans
- Pressure Regulated – 45 PSI available (6" only)

## Specifications

- Arc Adjustment Range: 40° – 360°
- Flow Range: 0.7 – 8.3 GPM (2,6 – 31 LPM)
- Pressure Rating: 20 – 70 PSI (1,4 – 4,8 bar)
- Precipitation Rate: .16 – 1.0 in/hr (4 – 25,4 mm/hr) (depending on spacing and nozzle used)
- Recommended Spacing: 25' – 45' (7,6 – 13,7 m)
- Radius: 22' – 51' (6,7 – 15,5 m)
- Nozzle Trajectory: 26°
- Low Angle Nozzle Trajectory: 11°
- 8 Standard and 4 Low Angle Nozzles Included

## Easy Arc Setting

Arc Selection: 40° to 360°  
Adjust from right start



## Accessories

See page 24-25



## Fast Facts

All	Inlet: 3/4" (1,9 cm) female thread NPT
4"	Retracted height: 7 3/8" (19,7 cm) Riser height: 4 3/8" (11,1 cm)
6"	Retracted height: 9 1/2" (24,1 cm) Riser height: 6 3/8" (16,2 cm)
Shrub	Height: 7 1/2" (19,1 cm)



# RPS™ 75

## Models

RPS75	RPS™ 75 Rotor
RPS75-360°	RPS™ 75 Rotor, 360°
RPS75-SH	RPS™ 75 Rotor, Shrub
RPS75-360°-SH	RPS™ 75 Rotor, 360°, Shrub
RPS75-6INCH	6" (15,2 cm) RPS™ 75 Rotor

## How to Specify with Options

MODEL	OPTION
RPS75	-SS Stainless Steel <b>NEW</b>
RPS75-360°	-CV Check valve
RPS75-SH	-NN No nozzle
RPS75-360°-SH	-RCW Reclaimed water use
RPS75-6INCH	-PR Pressure Regulation (6" only) <b>NEW</b>

Examples: RPS75-SS, RPS75-360°-RCW-CV

## Performance Data

NOZZLE	PRESSURE PSI	RADIUS Feet	FLOW GPM	PRECIP IN/HR	
				■	▲
#.75	30	29	0.7	.16	.19
	40	30	0.8	.17	.20
	50	30	0.9	.19	.22
	60	31	1.0	.20	.23
#1.0	30	30	0.9	.19	.22
	40	31	1.0	.20	.23
	50	31	1.2	.24	.28
	60	32	1.3	.24	.28
#1.5	30	32	1.2	.23	.26
	40	33	1.4	.25	.29
	50	34	1.6	.27	.31
	60	34	1.8	.30	.35
#2.0	30	34	1.6	.27	.31
	40	36	1.8	.27	.31
	50	38	2.0	.27	.31
	60	38	2.2	.29	.34
#3.0 Pre- Installed	30	36	2.0	.30	.34
	40	38	2.4	.32	.37
	50	40	2.7	.32	.38
	60	40	2.9	.35	.40
#4.0	30	36	2.6	.39	.45
	40	40	3.0	.36	.42
	50	42	3.4	.37	.43
	60	42	3.7	.40	.47
#6.0	40	38	4.2	.56	.65
	50	43	4.9	.51	.59
	60	46	5.5	.50	.58
	70	47	6.0	.52	.60
#8.0	40	45	6.0	.57	.66
	50	48	6.8	.57	.66
	60	49	7.6	.61	.70
	70	51	8.2	.61	.70

## PR Performance Data

NOZZLE	PRESSURE PSI	RADIUS Feet	FLOW GPM	PRECIP IN/HR	
				■	▲
#.75	30	29	0.7	0.16	0.19
	40	30	0.8	0.17	0.20
	50	30	0.9	0.19	0.22
	60	30	0.9	0.19	0.22
#1.0	30	30	0.9	0.19	0.22
	40	31	1.0	0.20	0.23
	50	31	1.2	0.24	0.28
	60	31	1.2	0.24	0.28
#1.5	30	32	1.2	0.23	0.26
	40	33	1.4	0.25	0.29
	50	34	1.6	0.27	0.31
	60	34	1.6	0.27	0.31
#2.0	30	34	1.6	0.27	0.31
	40	36	1.8	0.27	0.31
	50	38	2.0	0.27	0.31
	60	38	2.0	0.27	0.31
#3.0 Pre- Installed	30	36	2.0	0.30	0.34
	40	38	2.4	0.32	0.37
	50	40	2.7	0.32	0.38
	60	40	2.7	0.32	0.38
#4.0	30	36	2.6	0.39	0.45
	40	40	3.0	0.36	0.42
	50	42	3.4	0.37	0.43
	60	42	3.4	0.37	0.43
#6.0	40	38	4.2	0.56	0.65
	50	43	4.9	0.51	0.59
	60	43	4.9	0.51	0.59
	70	43	4.9	0.51	0.59
#8.0	40	45	6.0	0.57	0.66
	50	48	6.8	0.57	0.66
	60	48	6.8	0.57	0.66
	70	48	6.8	0.57	0.66

## Low Angle Performance Data

NOZZLE	PRESSURE PSI	RADIUS Feet	FLOW GPM	PRECIP IN/HR	
				■	▲
#1.0	30	22	1.2	.48	.55
	40	24	1.7	.57	.66
	50	26	1.8	.51	.59
	60	28	2.0	.49	.57
#3.0	30	29	3.0	.69	.79
	40	32	3.1	.58	.67
	50	35	3.5	.55	.64
	60	37	3.8	.53	.62
#4.0	30	31	3.4	.68	.79
	40	34	3.9	.65	.75
	50	37	4.4	.62	.71
	60	38	4.7	.63	.72
#6.0	40	38	6.5	.87	1.00
	50	40	7.3	.88	1.01
	60	42	8.0	.87	1.01
	70	44	8.3	.86	.99

## PR Low Angle Performance Data

NOZZLE	PRESSURE PSI	RADIUS Feet	FLOW GPM	PRECIP IN/HR	
				■	▲
#1.0	30	22	1.2	0.48	0.55
	40	24	1.7	0.57	0.66
	50	26	1.8	0.51	0.59
	60	26	1.8	0.51	0.59
#3.0	30	29	3.0	0.69	0.79
	40	32	3.1	0.58	0.67
	50	35	3.5	0.55	0.64
	60	35	3.5	0.55	0.64
#4.0	30	31	3.4	0.68	0.79
	40	34	3.9	0.65	0.75
	50	37	4.4	0.62	0.71
	60	37	4.4	0.62	0.71
#6.0	40	38	6.5	0.87	1.00
	50	40	7.3	0.88	1.01
	60	40	7.3	0.88	1.01
	70	40	7.3	0.88	1.01

Watch the video. Scan this code with your smartphone camera.



\*All precipitation rates calculated for 180° operation For the precipitation rate for a 360° sprinkler, divide by 2.

### Performance Data, Metric

NOZZLE	PRESSURE BAR	RADIUS Meter	FLOW L/M	PRECIP IN/HR	
				■	▲
#.75	2,1	8,8	2,6	4	5
	2,8	9,1	3,0	4	5
	3,4	9,1	3,4	5	6
	4,1	9,4	3,8	5	6
#1.0	2,1	9,1	3,4	5	6
	2,8	9,4	3,8	5	6
	3,4	9,4	4,5	6	7
	4,1	9,8	4,9	6	7
#1.5	2,1	9,8	4,5	5	7
	2,8	10,1	5,3	6	7
	3,4	10,4	6,1	7	8
	4,1	10,4	6,8	8	9
#2.0	2,1	10,4	6,1	7	8
	2,8	11,0	6,8	7	8
	3,4	11,6	7,6	7	8
	4,1	11,6	8,3	7	9
#3.0 Pre- Installed	2,1	11,0	7,6	8	9
	2,8	11,6	9,1	8	9
	3,4	12,2	10,2	8	10
	4,1	12,2	11,0	9	10
#4.0	2,1	11,0	9,8	10	11
	2,8	12,2	11,4	9	11
	3,4	12,8	12,9	9	11
	4,1	12,8	14,0	10	12
#6.0	2,8	11,6	15,9	14	17
	3,4	13,1	18,5	13	15
	4,1	14,0	20,8	13	15
	4,8	14,3	22,7	13	15
#8.0	2,8	13,7	22,7	14	17
	3,4	14,6	25,7	14	17
	4,1	14,9	28,8	15	18
	4,8	15,5	31,0	15	18

### PR Performance Data, Metric

NOZZLE	PRESSURE BAR	RADIUS Meter	FLOW L/M	PRECIP IN/HR	
				■	▲
#.75	2.1	8.8	2.7	4	5
	2.8	9.2	3.0	4	5
	3.5	9.2	3.4	5	6
	4.1	9.2	3.4	5	6
#1.0	2.1	9.2	3.4	5	6
	2.8	9.5	3.8	5	6
	3.5	9.5	4.5	6	7
	4.1	9.5	4.5	6	7
#1.5	2.1	9.8	4.5	6	7
	2.8	10.1	5.3	6	7
	3.5	10.4	6.1	7	8
	4.1	10.4	6.1	7	8
#2.0	2.1	10.4	6.1	7	8
	2.8	11.0	6.8	7	8
	3.5	11.6	7.6	7	8
	4.1	11.6	7.6	7	8
#3.0 Pre- Installed	2.1	11.0	7.6	8	9
	2.8	11.6	9.1	8	9
	3.5	12.2	10.2	8	10
	4.1	12.2	10.2	8	10
#4.0	2.1	11.0	9.9	10	11
	2.8	12.2	11.4	9	11
	3.5	12.8	12.9	9	11
	4.1	12.8	12.9	9	11
#6.0	2.8	11.6	15.9	14	17
	3.5	13.1	18.6	13	15
	4.1	13.1	18.6	13	15
	4.8	13.1	18.6	13	15
#8.0	2.8	13.7	22.7	14	17
	3.5	14.6	25.8	14	17
	4.1	14.6	25.8	14	17
	4.8	14.6	25.8	14	17

### Low Angle Performance Data, Metric

NOZZLE	PRESSURE BAR	RADIUS Meter	FLOW L/M	PRECIP IN/HR	
				■	▲
#1.0	2,1	6,7	4,5	12	14
	2,8	7,3	6,4	14	17
	3,4	7,9	6,8	13	15
	4,1	8,5	7,6	12	14
#3.0	2,1	8,8	11,4	18	20
	2,8	9,8	11,7	15	17
	3,4	10,7	13,2	14	16
	4,1	11,3	14,4	13	16
#4.0	2,1	9,4	12,9	17	20
	2,8	10,4	14,8	17	19
	3,4	11,3	16,7	16	18
	4,1	11,6	17,8	16	18
#6.0	2,8	11,6	24,6	22	25
	3,4	12,2	27,6	22	26
	4,1	12,8	30,3	22	26
	4,8	13,4	32,6	22	25

### PR Low Angle Performance Data, Metric

NOZZLE	PRESSURE BAR	RADIUS Meter	FLOW L/M	PRECIP IN/HR	
				■	▲
#1.0	2.1	6.7	4.5	12	14
	2.8	7.3	6.4	14	17
	3.5	7.9	6.8	13	15
	4.1	7.9	6.8	13	15
#3.0	2.1	8.8	11.4	18	20
	2.8	9.8	11.7	15	17
	3.5	10.7	13.3	14	16
	4.1	10.7	13.3	14	16
#4.0	2.1	9.5	12.9	17	20
	2.8	10.4	14.8	17	19
	3.5	11.3	16.7	16	18
	4.1	11.3	16.7	16	18
#6.0	2.8	11.6	24.6	22	25
	3.5	12.2	27.7	22	26
	4.1	12.2	27.7	22	26
	4.8	12.2	27.7	22	26



# RPS™ 75i

With Patented Intelligent Flow Technology®.

## Features

- Reduce Distance and Flow Rate Simultaneously and Proportionately up to 50%
- Shut off flow from the head
- Rugged RPS Family Construction
- Superior Uniformity, Conserves Water, Fewer Zones Required
- Save Time on Every Project — New or retrofit
- Includes 5 Free Check Valve Assemblies Per Box
- Universal Riser Assembly – Fits into existing Hunter® PGP® and PGP® Ultra cans
- Pressure Regulated – 45 PSI available (6" only)

## Specifications

- Arc Adjustment Range: 40° – 360°
- Flow Range: 0.9 – 9.7 GPM (3,4 – 36,7 LPM)
- Pressure Rating: 20 – 70 PSI (1,4 – 4,8 bar)
- Precipitation Rate: .22 – .98 in/hr (6 – 24,9 mm/hr)
- Recommended Spacing: 17' – 45' (5,2 – 13,7 m)
- Radius: 26' – 48' (7,9 – 14,6 m)
- Nozzle Trajectory: 26°
- Low Angle Nozzle Trajectory: 11°
- Nozzles Included: 8 Standard, 4 Low Angle

## Models

<b>RPS 75i</b>	RPS™ 75i Rotor
<b>RPS75i-360°</b>	RPS™ 75i Rotor, 360°
<b>RPS75i-SH</b>	RPS™ 75i Rotor, Shrub
<b>RPS75i-360°-SH</b>	RPS™ 75i Rotor, Shrub, 360°
<b>RPS75i-6INCH</b>	6" (15,2 cm) RPS™ 75i Rotor

## Accessories

See page 24-25

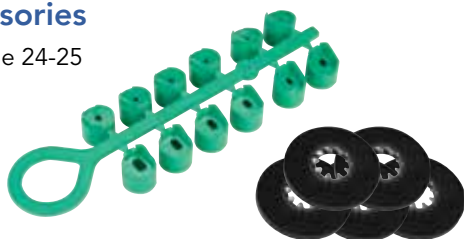

## Fast Facts

All	Inlet: 3/4" (1,9 cm) female thread NPT
4"	Retracted height: 7 3/8" (19,7 cm) Riser height: 4 1/4" (10,8 cm)
6"	Retracted height: 9 1/2" (24,1 cm) Riser height: 6 1/4" (15,9 cm)
Shrub	Height: 7 1/2" (19,1 cm)





Intelligent Flow Technology®

- Reduces distance and flow rate simultaneously and proportionately up to 50%
- Provides full on/off control

### How to Specify with Options

MODEL	OPTION
RPS75i	-SS Stainless Steel <b>NEW</b>
RPS75i-360°	-CV Check valve
RPS75i-SH	-NN No nozzle
RPS75i-360°-SH	-RCW Reclaimed water use
RPS75i-6INCH	-PR Pressure Regulation (6" only) <b>NEW</b>

Examples: RPS75i-NN, RPS75-360°-RCW



Watch the video. Scan this code with your smartphone camera.

### Performance Data

NOZZLE	PRESSURE PSI	NO ADJUSTMENT			-30% ADJUSTMENT		
		RADIUS Feet	FLOW GPM	PRECIP IN/HR ■ ▲	RADIUS Feet	FLOW GPM	PRECIP IN/HR ■ ▲
#1.0	30	31	1.1	.22 .25	22	0.8	.31 .36
	40	32	1.4	.26 .30	22	1.0	.38 .43
	50	33	1.6	.28 .33	23	1.1	.40 .47
	60	34	1.8	.30 .35	24	1.3	.43 .49
#1.5	30	33	1.5	.27 .31	23	1.1	.38 .44
	40	35	1.8	.28 .33	25	1.3	.40 .47
	50	35	2	.31 .36	25	1.4	.45 .52
#2.0	30	33	1.8	.32 .37	23	1.3	.45 .53
	40	34	2.1	.35 .40	24	1.5	.50 .58
	50	36	2.4	.36 .41	25	1.7	.51 .59
#2.5 Pre- installed	30	35	2.2	.35 .40	25	1.5	.49 .57
	40	38	2.6	.35 .40	27	1.8	.50 .57
	50	39	3	.38 .44	27	2.1	.54 .63
#3.0	30	38	2.7	.36 .42	27	1.9	.51 .59
	40	40	3.1	.37 .43	28	2.2	.53 .62
	50	41	3.5	.40 .46	29	2.5	.57 .66
#4.0	30	38	3.5	.47 .54	27	2.5	.67 .77
	40	40	4	.48 .56	28	2.8	.69 .79
	50	43	4.4	.46 .53	30	3.1	.65 .76
#5.0	30	43	4.4	.46 .53	30	3.1	.65 .76
	40	43	5	.52 .60	30	3.5	.74 .86
	50	44	5.5	.55 .63	31	3.9	.78 .90
#6.0	30	43	4.9	.51 .59	30	3.4	.73 .84
	40	43	5	.60 .70	28	3.5	.86 .99
	50	43	5.9	.61 .71	30	4.1	.88 1.01
#8.0	30	43	6.8	.71 .82	30	4.8	1.01 1.17
	40	47	7.9	.69 .80	33	5.5	.98 1.14
	50	48	8.8	.74 .85	34	6.2	1.05 1.21
60	47	9.7	.85 .98	33	6.8	1.21 1.40	

### Low Angle Performance Data

NOZZLE	PRESSURE PSI	NO ADJUSTMENT			-30% ADJUSTMENT		
		RADIUS Feet	FLOW GPM	PRECIP IN/HR ■ ▲	RADIUS Feet	FLOW GPM	PRECIP IN/HR ■ ▲
#1.0	30	26	0.9	.25 .29	18	0.6	0.35 0.41
	40	27	1.0	.26 .31	19	0.7	0.38 0.44
	50	27	1.2	.32 .37	19	0.8	0.45 0.52
	60	26	1.4	.40 .46	18	1.0	0.57 0.66
#1.5	30	28	1.3	.32 .37	20	0.9	0.46 0.53
	40	29	1.5	.34 .40	20	1.1	0.49 0.57
	50	30	1.7	.36 .42	21	1.2	0.52 0.6
	60	31	1.9	.38 .44	22	1.3	0.54 0.63
#2.0	30	29	1.9	.44 .50	20	1.3	0.62 0.72
	40	32	2.2	.41 .48	22	1.5	0.59 0.68
	50	33	2.5	.44 .51	23	1.8	0.63 0.73
	60	34	2.8	.47 .54	24	2.0	0.67 0.77
#3.0	30	32	2.5	.47 .54	22	1.8	0.67 0.78
	40	34	3.0	.50 .58	24	2.1	0.71 0.82
	50	35	3.5	.55 .64	25	2.5	0.79 0.91
	60	36	4.0	.59 .69	25	2.8	0.85 0.98

\*All precipitation rates calculated for 180° operation.  
For the precipitation rate for a 360° sprinkler, divide by 2.

# RPS™ 75i



## PR Performance Data

NOZZLE	PRESSURE PSI	NO ADJUSTMENT				-30% ADJUSTMENT			
		RADIUS Feet	FLOW GPM	PRECIP IN/HR ■ ▲		RADIUS Feet	FLOW GPM	PRECIP IN/HR ■ ▲	
#1.0	30	31	1.1	0.22	0.25	22	0.8	0.31	0.36
	40	32	1.4	0.26	0.30	22	1.0	0.37	0.43
	50	33	1.6	0.28	0.33	23	1.1	0.40	0.47
	60	33	1.6	0.28	0.33	23	1.1	0.40	0.47
#1.5	30	33	1.5	0.27	0.31	23	1.1	0.39	0.44
	40	35	1.8	0.28	0.33	25	1.3	0.40	0.47
	50	35	2.0	0.31	0.36	25	1.4	0.44	0.51
	60	35	2.0	0.31	0.36	25	1.4	0.44	0.51
#2.0	30	33	1.8	0.32	0.37	23	1.3	0.46	0.53
	40	34	2.1	0.35	0.40	24	1.5	0.50	0.57
	50	36	2.4	0.36	0.41	25	1.7	0.51	0.59
	60	36	2.4	0.36	0.41	25	1.7	0.51	0.59
#2.5 Pre- installed	30	35	2.2	0.35	0.40	25	1.5	0.50	0.57
	40	38	2.6	0.35	0.40	27	1.8	0.50	0.57
	50	39	3.0	0.38	0.44	27	2.1	0.54	0.63
	60	39	3.0	0.38	0.46	27	2.1	0.54	0.66
#3.0	30	38	2.7	0.36	0.42	27	1.9	0.51	0.60
	40	40	3.1	0.37	0.43	28	2.2	0.53	0.61
	50	41	3.5	0.40	0.46	29	2.5	0.57	0.66
	60	41	3.5	0.40	0.46	29	2.5	0.57	0.66
#4.0	30	38	3.5	0.47	0.54	27	2.5	0.67	0.77
	40	40	4.0	0.48	0.56	28	2.8	0.69	0.80
	50	43	4.4	0.46	0.53	30	3.1	0.66	0.76
	60	43	4.4	0.46	0.53	30	3.1	0.66	0.76
#5.0	30	43	4.4	0.46	0.53	30	3.1	0.66	0.76
	40	43	5.0	0.52	0.60	30	3.5	0.74	0.86
	50	44	5.5	0.55	0.63	31	3.9	0.79	0.90
	60	44	5.5	0.55	0.63	31	3.9	0.79	0.90
#6.0	30	40	5.0	0.60	0.70	28	3.5	0.86	1.00
	40	43	5.9	0.61	0.71	30	4.1	0.87	1.01
	50	43	6.6	0.69	0.79	30	4.6	0.99	1.13
	60	43	6.6	0.69	0.79	30	4.6	0.99	1.13
#8.0	30	43	6.8	0.71	0.82	30	4.8	1.01	1.17
	40	47	7.9	0.69	0.80	33	5.5	0.99	1.14
	50	48	8.8	0.74	0.85	34	6.2	1.06	1.21
	60	48	8.8	0.74	0.85	34	6.2	1.06	1.21

## PR Low Angle Performance Data

NOZZLE	PRESSURE PSI	NO ADJUSTMENT				-30% ADJUSTMENT			
		RADIUS Feet	FLOW GPM	PRECIP IN/HR ■ ▲		RADIUS Feet	FLOW GPM	PRECIP IN/HR ■ ▲	
#1.0	30	26	0.9	0.25	0.29	18	0.6	0.36	0.41
	40	27	1.0	0.26	0.31	19	0.7	0.37	0.44
	50	27	1.2	0.32	0.37	19	0.8	0.46	0.53
	60	27	1.2	0.32	0.37	19	0.8	0.46	0.53
#1.5	30	28	1.3	0.32	0.37	20	0.9	0.46	0.53
	40	29	1.5	0.34	0.40	20	1.1	0.49	0.57
	50	30	1.7	0.36	0.42	21	1.2	0.51	0.60
	60	30	1.7	0.36	0.42	21	1.2	0.51	0.60
#2.0	30	29	1.9	0.44	0.50	20	1.3	0.63	0.71
	40	32	2.2	0.41	0.48	22	1.5	0.59	0.69
	50	33	2.5	0.44	0.51	23	1.8	0.63	0.73
	60	33	2.5	0.44	0.51	23	1.8	0.63	0.73
#3.0	30	32	2.5	0.47	0.54	22	1.8	0.67	0.77
	40	34	3.0	0.50	0.58	24	2.1	0.71	0.83
	50	35	3.5	0.55	0.64	25	2.5	0.79	0.91
	60	35	3.5	0.55	0.64	25	2.5	0.79	0.91

### Performance Data, Metric

NOZZLE	PRESSURE BAR	NO ADJUSTMENT				-30% ADJUSTMENT			
		RADIUS Meter	FLOW L/M	PRECIP IN/HR ■ ▲		RADIUS Meter	FLOW L/M	PRECIP IN/HR ■ ▲	
#1.0	2,1	9,4	4,2	6	6	7	3,0	8	9
	2,8	9,8	5,3	7	8	7	3,8	10	11
	3,4	10,1	6,1	7	8	7	4,1	10	12
	4,1	10,4	6,8	8	9	7	4,9	11	12
#1.5	2,1	10,1	5,7	7	8	7	4,1	10	11
	2,8	10,7	6,8	7	8	8	4,9	10	12
	3,4	10,7	7,6	8	9	8	5,3	11	13
	4,1	11,0	8,3	8	10	8	5,7	12	14
#2.0	2,1	10,1	6,8	8	9	7	4,9	11	13
	2,8	10,4	7,9	9	10	7	5,7	13	15
	3,4	11,0	9,1	9	10	8	6,4	13	15
	4,1	11,6	10,2	9	11	8	7,2	13	15
#2.5 Pre- installed	2,1	10,7	8,3	9	10	8	5,7	12	14
	2,8	11,6	9,8	9	10	8	6,8	13	14
	3,4	11,9	3,6	10	11	8	7,9	14	16
	4,1	12,2	3,7	10	12	9	8,7	14	17
#3.0	2,1	11,6	10,2	9	11	8	7,1	13	15
	2,8	12,2	11,7	9	11	9	8,3	13	16
	3,4	12,5	13,3	10	12	9	9,5	14	17
	4,1	12,5	14,8	11	13	9	10,2	16	19
#4.0	2,1	11,6	13,3	12	14	8	9,5	17	20
	2,8	12,2	15,1	12	14	9	10,6	18	20
	3,4	13,1	16,7	12	13	9	11,7	17	19
	4,1	13,1	18,6	13	15	9	12,9	19	21
#5.0	2,1	13,1	6,7	12	13	9	11,7	17	19
	2,8	13,1	18,9	13	15	9	13,3	19	22
	3,4	13,4	20,8	14	16	9	14,8	20	23
	4,1	12,8	22,3	16	19	9	15,5	23	27
#6.0	2,1	12,2	18,9	15	18	9	13,3	22	25
	2,8	13,1	22,3	15	18	9	15,5	22	26
	3,4	13,1	25,0	18	20	9	17,4	25	29
	4,1	13,4	27,6	19	21	9	19,3	26	30
#8.0	2,1	13,1	25,7	18	21	9	18,2	26	30
	2,8	14,3	29,9	18	20	10	20,8	25	29
	3,4	14,6	33,3	19	22	10	23,5	27	31
	4,1	14,3	36,7	22	25	10	25,7	31	35

### PR Performance Data, Metric

NOZZLE	PRESSURE BAR	NO ADJUSTMENT				-30% ADJUSTMENT			
		RADIUS Meter	FLOW L/M	PRECIP IN/HR ■ ▲		RADIUS Meter	FLOW L/M	PRECIP IN/HR ■ ▲	
#1.0	2,1	9,5	4,2	6	6	6,6	2,9	8	9
	2,8	9,8	5,3	7	8	6,8	3,7	9	11
	3,5	10,1	6,1	7	8	7,0	4,2	10	12
	4,1	10,1	6,1	7	8	7,0	4,2	10	12
#1.5	2,1	10,1	5,7	7	8	7,0	4,0	10	11
	2,8	10,7	6,8	7	8	7,5	4,8	10	12
	3,5	10,7	7,6	8	9	7,5	5,3	11	13
	4,1	10,7	7,6	8	9	7,5	5,3	11	13
#2.0	2,1	10,1	6,8	8	9	7,0	4,8	12	13
	2,8	10,4	8,0	9	10	7,3	5,6	13	15
	3,5	11,0	9,1	9	10	7,7	6,4	13	15
	4,1	11,0	9,1	9	10	7,7	6,4	13	15
#2.5 Pre- installed	2,1	10,7	8,3	9	10	7,5	5,8	13	15
	2,8	11,6	9,9	9	10	8,1	6,9	13	15
	3,5	11,9	11,4	10	11	8,3	8,0	14	16
	4,1	11,9	11,4	10	12	8,3	8,0	14	17
#3.0	2,1	11,6	10,2	9	11	8,1	7,2	13	15
	2,8	12,2	11,7	9	11	8,5	8,2	13	16
	3,5	12,5	13,3	10	12	8,8	9,3	15	17
	4,1	12,5	13,3	10	12	8,8	9,3	15	17
#4.0	2,1	11,6	13,3	12	14	8,1	9,3	17	20
	2,8	12,2	15,2	12	14	8,5	10,6	17	20
	3,5	13,1	16,7	12	13	9,2	11,7	17	19
	4,1	13,1	16,7	12	13	9,2	11,7	17	19
#5.0	2,1	13,1	16,7	12	13	9,2	11,7	17	19
	2,8	13,1	19,0	13	15	9,2	13,3	19	22
	3,5	13,4	20,8	14	16	9,4	14,6	20	23
	4,1	13,4	20,8	14	16	9,4	14,6	20	23
#6.0	2,1	12,2	19,0	15	18	8,5	13,3	22	25
	2,8	13,1	22,4	15	18	9,2	15,7	22	26
	3,5	13,1	25,0	18	20	9,2	17,5	25	29
	4,1	13,1	25,0	18	20	9,2	17,5	25	29
#8.0	2,1	13,1	25,8	18	21	9,2	18,0	26	30
	2,8	14,3	29,9	18	20	10,0	21,0	25	29
	3,5	14,6	33,4	19	22	10,2	23,3	27	31
	4,1	14,6	33,4	19	22	10,2	23,3	27	31

### Low Angle Performance Data, Metric

NOZZLE	PRESSURE BAR	NO ADJUSTMENT				-30% ADJUSTMENT			
		RADIUS Meter	FLOW L/M	PRECIP IN/HR ■ ▲		RADIUS Meter	FLOW L/M	PRECIP IN/HR ■ ▲	
#1.0	2,1	7,9	3,4	6	7	5	2,3	9	10
	2,8	8,2	3,8	7	8	6	2,7	10	11
	3,4	8,2	4,5	8	9	6	3,0	11	13
	4,1	7,9	5,3	10	12	5	3,8	14	17
#1.5	2,1	8,5	4,9	8	9	6	3,4	12	13
	2,8	8,8	5,7	9	10	6	4,2	12	14
	3,4	9,1	6,4	9	11	6	4,5	13	15
	4,1	9,4	7,2	10	11	7	4,9	14	16
#2.0	2,1	8,8	7,2	11	13	6	4,9	16	18
	2,8	9,8	8,3	10	12	7	5,7	15	17
	3,4	10,1	9,5	11	13	7	6,8	16	19
	4,1	10,4	10,6	12	14	7	7,6	17	20
#3.0	2,1	9,8	9,5	13	14	7	6,8	17	20
	2,8	10,4	11,4	14	15	7	7,9	18	21
	3,4	10,7	13,3	14	16	8	9,5	20	23
	4,1	11,0	15,1	15	18	8		22	25

### PR Low Angle Performance Data, Metric

NOZZLE	PRESSURE BAR	NO ADJUSTMENT				-30% ADJUSTMENT			
		RADIUS Meter	FLOW L/M	PRECIP IN/HR ■ ▲		RADIUS Meter	FLOW L/M	PRECIP IN/HR ■ ▲	
#1.0	2,1	7,9	3,4	6	7	5,6	2,4	9	11
	2,8	8,2	3,8	7	8	5,8	2,7	9	11
	3,5	8,2	4,5	8	9	5,8	3,2	12	13
	4,1	8,2	4,5	8	9	5,8	3,2	12	13
#1.5	2,1	8,5	4,9	8	9	6,0	3,4	12	13
	2,8	8,8	5,7	9	10	6,2	4,0	12	15
	3,5	9,2	6,4	9	11	6,4	4,5	13	15
	4,1	9,2	6,4	9	11	6,4	4,5	13	15
#2.0	2,1	8,8	7,2	11	13	6,2	5,0	16	18
	2,8	9,8	8,3	10	12	6,8	5,8	15	17
	3,5	10,1	9,5	11	13	7,0	6,6	16	19
	4,1	10,1	9,5	11	13	7,0	6,6	16	19
#3.0	2,1	9,8	9,5	12	14	6,8	6,6	17	20
	2,8	10,4	11,4	13	15	7,3	8,0	18	21
	3,5	10,7	13,3	14	16	7,5	9,3	20	23
	4,1	10,7	13,3	14	16	7,5	9,3	20	23

\*All precipitation rates calculated for 180° operation. For the precipitation rate for a 360° sprinkler, divide by 2.

# RPS™ Select

Four built-in selectable nozzles for the fastest nozzle change of any rotor.

## Features

- All adjustments made from the top – wet or dry – including flow shutoff. No special tools needed
- Four Built-in Selectable Nozzles – Nozzles #1 through #4 match arc settings 90° through 360°
- Matched Precipitation Rates – When nozzle setting matched to arc
- Precision-Engineered Nozzles – Ensures water-saving efficiency
- Standard Rubber Cover
- Proven Water-lubricated Gear-drive Design – Common to the popular RPS™ 75 Series
- Low-pressure Operation
- Universal Riser Assembly – Fits into existing Hunter® PGP® and PGP® Ultra cans

## Specifications

- Arc Adjustment Range: 40° – 360°
- Flow Range: 1.3 – 6.8 GPM (4,9 – 25,8 LPM)
- Pressure Rating: 20 – 70 PSI (1,4 – 4,8 bar)
- Precipitation Rate: .23 – .71 in/hr (6 – 20 mm/hr) (depending on spacing and nozzle used)
- Recommended Spacing: 31' – 44' (9,4 – 13,4 m)
- Radius: 33' – 46' (10 – 14 m)
- Nozzle Trajectory: 24°

## Models

<b>60003</b>	RPS™ Select Rotor
<b>60003-SH</b>	RPS™ Select Rotor, Shrub
<b>60003-6INCH</b>	6" (15,2 cm) RPS™ Select Rotor

## Fast Facts

All	Inlet: 3/4" (1,9 cm) female thread NPT
4"	Retracted height: 7 3/8" (19,7 cm) Riser height: 4 3/8" (11,1 cm)
6"	Retracted height: 9 1/2" (24,1 cm) Riser height: 6 3/8" (16,2 cm)
Shrub	Height: 7 5/8" (16,8 cm)



### Nozzle Selector

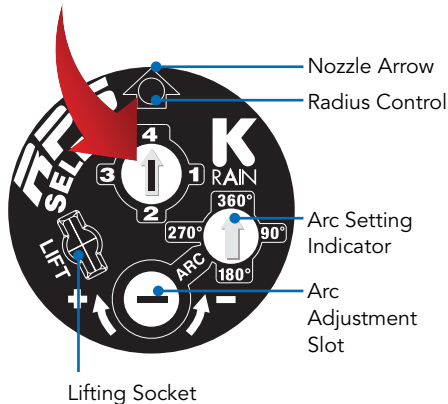



## Performance Data

NOZZLE	PRESSURE PSI	RADIUS Feet	FLOW GPM	PRECIP in/hr	
				■	▲
#1.0	30	33'	1.3	.23	.24
	35	34'	1.4	.23	.27
	40	37'	1.5	.21	.29
	45	37'	1.6	.22	.26
	50	37'	1.8	.25	.29
#2.0	30	37'	2.6	.37	.42
	35	38'	2.8	.37	.43
	40	39'	3.0	.38	.44
	45	40'	3.2	.39	.44
	50	40'	3.6	.43	.50
#3.0	30	37'	3.8	.53	.62
	35	40'	4.1	.49	.57
	40	41'	4.5	.52	.60
	45	41'	4.7	.54	.62
	50	43'	4.9	.51	.59
#4.0	30	38'	5.2	.69	.80
	35	40'	5.7	.69	.79
	40	44'	6.0	.60	.69
	45	45'	6.4	.61	.70
	50	46'	6.8	.62	.71

## Performance Data, Metric

NOZZLE	PRESSURE Bar	RADIUS Meters	FLOW L/M	PRECIP mm/hr	
				■	▲
#1.0	2,1	10,1	4,9	6	6
	2,4	10,4	5,3	6	7
	2,8	10,4	5,7	5	7
	3,1	11,3	6,1	6	7
	3,4	11,3	6,8	6	7
#2.0	2,1	11,3	9,8	9	11
	2,4	11,6	10,6	9	11
	2,8	11,9	11,4	10	11
	3,1	12,2	12,1	10	11
	3,4	12,2	13,6	11	13
#3.0	2,1	11,3	14,4	13	16
	2,4	12,2	15,5	12	14
	2,8	12,2	17,0	13	15
	3,1	12,5	17,8	14	16
	3,4	13,1	18,5	13	15
#4.0	2,1	11,6	19,6	18	20
	2,4	12,2	21,5	18	20
	2,8	13,4	22,7	15	18
	3,1	13,7	24,2	15	18
	3,4	14,0	25,7	16	18

\*All precipitation rates calculated for 180° operation.  
For the precipitation rate for a 360° sprinkler, divide by 2.

## How to Specify with Options

MODEL	OPTION
60003	-CV Check valve
60003-SH	-RCW Reclaimed water use
60003-6INCH	

Examples: 60003-6INCH-CV, 60003-RCW

## Accessories

See page 24-25



Watch the video. Scan this code with your smartphone camera.

# ProPlus®

Tough, proven and advanced.

## Features

- Patented Top Arc Set – Allows for wet or dry adjustment in seconds
- Full arc range adjustment from 40° to continuous 360°
- Patented Arc Set Degree Markings – Clearly indicates current watering pattern & simplifies arc set adjustment
- Arc Memory Clutch – Prevents internal gear damage and returns rotor to its prior setting automatically if nozzle turret is forced past its stop
- Patented Reversing Mechanism – Assures continuous reverse and return
- Ratcheting Riser – Allows for easy adjustment of the fixed starting position with a simple turn of the riser
- Rubber Cover – Seals out dirt, increases product durability
- Wide Selection of Nozzles – Including standard and low angle, provides flexibility in system design
- Replaces all standard rotors
- Optional Check Valve – Prevents low head drainage

## Specifications

- Arc Adjustment Range: 40° to Continuous 360°
- Flow Range: .5 – 10.0 GPM (1,9 – 37,8 LPM)
- Pressure Rating: 20 – 70 PSI (1,4 – 4,8 bar)
- Precipitation Rate: .12 – 1.01 in/hr (3 – 25,7 mm/hr) (depending on spacing and nozzle used)
- Recommended Spacing: 28' – 44' (8,5 – 13,4 m)
- Radius: 22' – 50' (6,7 – 15,2 m)
- Nozzle Trajectory: 26°
- Low Angle Nozzle Trajectory: 12°
- Standard and Low Angle Nozzles Included

## Model

11003 ProPlus®

## Accessories

See page 24-25

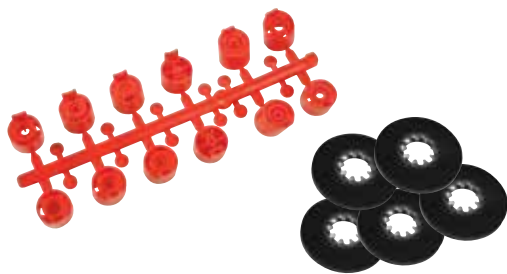

## Fast Facts

Inlet: 3/4" (1,9 cm) female thread NPT

Retracted height: 7 1/2" (19 cm)

Riser height: 4 1/4" (10,8 cm)

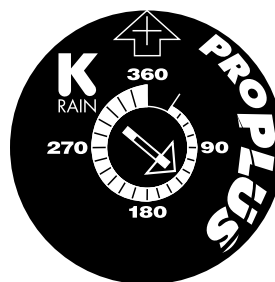

## Easy Arc Setting

Arc Selection: 40° to continuous 360°  
Adjust from left start



## Performance Data

NOZZLE	PRESSURE PSI	RADIUS Feet	FLOW GPM	PRECIP in/hr	
				■	▲
#0.5	30	28	0.5	.12	.14
	40	29	0.6	.14	.16
	50	29	0.7	.16	.19
	60	30	0.8	.17	.20
#0.75	30	29	0.7	.16	.19
	40	30	0.8	.17	.20
	50	31	0.9	.18	.21
	60	32	1.0	.19	.22
#1.0	30	32	1.3	.24	.28
	40	33	1.5	.27	.31
	50	34	1.6	.27	.31
	60	35	1.8	.28	.33
#2.0	30	37	2.4	.34	.39
	40	40	2.5	.30	.35
	50	42	3.0	.33	.38
	60	43	3.3	.34	.36
#2.5 Pre- installed	30	38	2.5	.33	.38
	40	39	2.8	.35	.41
	50	40	3.2	.39	.44
	60	41	3.5	.40	.46
#3.0	30	38	3.6	.48	.55
	40	39	4.2	.53	.61
	50	41	4.6	.53	.61
	60	42	5.0	.55	.63
#4.0	30	43	4.4	.46	.53
	40	44	5.1	.51	.59
	50	46	5.6	.51	.59
	60	49	5.9	.47	.55
#6.0	40	45	5.9	.56	.65
	50	46	6.0	.55	.63
	60	48	6.3	.53	.61
	70	49	6.7	.54	.62
#8.0	40	42	8.0	.87	1.01
	50	45	8.5	.81	.93
	60	49	9.5	.76	.88
	70	50	10.0	.77	.89

## Performance Data, Metric

NOZZLE	PRESSURE Bar	RADIUS Meters	FLOW L/M	PRECIP mm/hr	
				■	▲
#0.5	2,1	8,5	1,9	3	4
	2,8	8,8	2,3	4	4
	3,4	8,8	2,7	4	5
	4,1	9,1	3,0	5	5
#0.75	2,1	8,8	2,7	4	5
	2,8	9,1	3,0	4	5
	3,4	9,4	3,4	5	5
	4,1	9,8	3,8	5	6
#1.0	2,1	9,8	4,9	6	7
	2,8	10,1	5,7	7	8
	3,4	10,4	6,1	7	8
	4,1	10,7	6,8	7	8
#2.0	2,1	11,3	9,1	9	10
	2,8	12,2	9,5	8	9
	3,4	12,8	11,4	8	10
	4,1	13,1	11,4	8	9
#2.5 Pre- installed	2,1	11,6	9,5	8	10
	2,8	11,9	10,6	9	10
	3,4	12,2	12,1	10	11
	4,1	12,5	13,3	10	12
#3.0	2,1	11,6	13,6	12	14
	2,8	11,9	15,9	13	15
	3,4	12,5	17,4	13	15
	4,1	12,8	19,0	14	16
#4.0	2,1	13,1	16,7	12	13
	2,8	13,4	19,3	13	15
	3,4	14,0	21,2	13	15
	4,1	14,9	22,4	12	14
#6.0	2,8	13,7	22,4	14	17
	3,4	14,0	22,7	14	16
	4,1	14,6	23,9	13	15
	4,8	14,9	25,4	14	16
#8.0	2,8	12,8	30,3	22	26
	3,4	13,7	32,2	21	24
	4,1	14,9	36,0	19	22
	4,8	15,2	37,9	20	23

## Low Angle Performance Data

NOZZLE	PRESSURE PSI	RADIUS Feet	FLOW GPM	PRECIP in/hr	
				■	▲
#1.0	30	22	1.2	.48	.55
	40	24	1.7	.57	.66
	50	26	1.8	.51	.59
	60	28	2.0	.49	.57
#3.0	30	29	3.0	.69	.79
	40	32	3.1	.58	.67
	50	35	3.5	.55	.64
	60	37	3.8	.53	.62
#4.0	30	31	3.4	.68	.79
	40	34	3.9	.65	.75
	50	37	4.4	.62	.71
	60	38	4.7	.63	.72
#6.0	40	38	6.5	.87	1.00
	50	40	7.3	.88	1.01
	60	42	8.0	.87	1.01
	70	44	8.3	.86	0.99

## Low Angle Performance Data, Metric

NOZZLE	PRESSURE Bar	RADIUS Meters	FLOW L/M	PRECIP mm/hr	
				■	▲
#1.0	2,1	6,7	4,5	12	14
	2,8	7,3	6,4	14	17
	3,4	7,9	6,8	13	15
	4,1	8,5	7,6	12	14
#3.0	2,1	8,8	11,4	18	20
	2,8	9,8	11,7	15	17
	3,4	10,7	13,2	14	16
	4,1	11,3	14,4	14	16
#4.0	2,1	9,4	12,9	17	20
	2,8	10,4	14,8	17	19
	3,4	11,3	16,7	16	18
	4,1	11,6	17,8	16	18
#6.0	2,8	11,6	24,6	22	25
	3,4	12,2	27,7	22	26
	4,1	12,8	30,3	22	26
	4,8	13,4	32,6	22	25

\*All precipitation rates calculated for 180° operation. For the precipitation rate for a 360° sprinkler, divide by 2.

## How to Specify with Options

MODEL	OPTION
11003	-CV Check valve
	-LA Low angle nozzle
	-NN No nozzle
	-RCW Reclaimed water use

Example: 11003-RCW-CV

# SuperPro®

All the best features in one rotor including Intelligent Flow Technology®.

## Features

- Patented Intelligent Flow Technology® – Reduce distance and water flow simultaneously and proportionately up to 50%. Water savings of up to 30%
- Patented easy arc set – Simplified setting wet or dry. Water flow can be turned off or adjusted in the popped-up position
- Adjustable or continuous rotation – Provides a full range of adjustment from 40° to continuous 360°
- Patented arc set degree markings – Clearly indicates current watering pattern, simplifies arc set adjustment
- Arc memory clutch – Prevents internal gear damage and returns rotor to its prior setting automatically if nozzle turret is forced out of adjustment
- Patented reversing mechanism – Assures continuous reverse and return
- Ratcheting riser – Allows for easy adjustment of your left starting position with a simple turn of the riser
- Rubber cover – Seals out dirt and increases durability
- Optional check valve – Prevents low head drainage
- Rugged stainless steel spring – .093 gauge 302 stainless steel spring extends the life of the rotor

## Specifications

- Arc adjustment range: 40° to continuous 360°
- Flow range: .8 – 11.1 GPM (3,0 – 42,0 LPM)
- Pressure rating: 20 – 70 PSI (1,4 – 4,8 bar)
- Precipitation rate: .21 – 1.17 in/hr (5,3 – 29,7 mm/hr) (depending on spacing and nozzle used)
- Recommended spacing: 28' – 44' (8,5 – 13,4 m)
- Radius: 26' – 46' (7,9 – 14,0 m)
- Nozzle trajectory: 26°
- Low angle nozzle trajectory: 12°
- Standard and low angle nozzles included

## Models

- 10003** SuperPro
- 10003-HP** SuperPro High Pop
- 10003-SH** SuperPro Shrub

## Fast Facts

All	Inlet: 3/4" (1,9 cm) female thread NPT
Standard	Retracted height: 7 1/2" (19,0 cm) Riser height: 4 3/4" (12,1 cm)
High pop	Retracted height: 17 (43,2 cm) Riser height: 11 1/2" (29,2 cm)
Shrub	Height: 7 3/4" (19,7 cm)



## Performance Data

NOZZLE	PRESSURE PSI	NO ADJUSTMENT				-30% ADJUSTMENT			
		RADIUS Feet	FLOW GPM	PRECIP in/hr ■ ▲		RADIUS Feet	FLOW GPM	PRECIP in/hr ■ ▲	
#1.0	30	30	1.2	.21	.25	21	0.8	.30	.36
	40	31	1.3	.23	.27	22	0.9	.33	.39
	50	31	1.5	.27	.31	22	1.1	.39	.44
	60	32	1.8	.32	.37	22	1.3	.46	.53
#1.5	30	36	1.5	.22	.26	25	1.1	.31	.37
	40	37	1.8	.25	.29	26	1.3	.36	.41
	50	37	2.0	.28	.32	26	1.4	.40	.46
	60	38	2.2	.29	.34	27	1.5	.41	.49
#2.0	30	35	1.8	.28	.33	25	1.3	.40	.47
	40	35	2.2	.35	.40	25	1.5	.50	.57
	50	36	2.6	.39	.45	25	1.8	.56	.64
	60	38	2.9	.39	.45	27	2.0	.56	.64
#2.5 Pre- installed	30	37	2.5	.35	.41	26	1.8	.50	.59
	40	38	3.0	.40	.46	27	2.1	.57	.66
	50	40	3.4	.41	.47	28	2.4	.59	.67
	60	40	3.8	.46	.53	28	2.7	.66	.76
#3.0	30	36	3.0	.45	.51	25	2.1	.64	.73
	40	37	3.4	.48	.55	26	2.4	.69	.79
	50	38	4.0	.53	.62	27	2.8	.76	.89
	60	41	4.4	.50	.58	29	3.1	.71	.83
#4.0	30	37	4.0	.56	.65	26	2.8	.80	.93
	40	39	4.5	.57	.66	27	3.2	.81	.94
	50	39	5.2	.66	.76	27	3.6	.94	1.09
	60	40	5.6	.67	.78	28	3.9	.96	1.11
#5.0	30	37	4.8	.68	.78	26	3.4	.97	1.11
	40	38	5.6	.75	.86	27	3.9	1.07	1.23
	50	41	6.5	.74	.86	29	4.6	1.06	1.23
	60	43	7.2	.75	.87	30	5.0	1.07	1.24
#6.0	30	40	6.0	.72	.83	28	4.2	1.03	1.19
	40	41	6.8	.78	.90	29	4.8	1.11	1.29
	50	42	7.5	.82	.95	29	5.3	1.17	1.36
	60	44	8.4	.84	.96	31	5.9	1.20	1.37
#8.0	30	38	7.9	1.05	1.22	27	5.5	1.50	1.74
	40	44	9.2	.92	1.06	31	6.4	1.31	1.51
	50	45	10.4	.99	1.14	32	7.3	1.41	1.63
	60	46	11.1	1.01	1.17	32	7.8	1.44	1.67

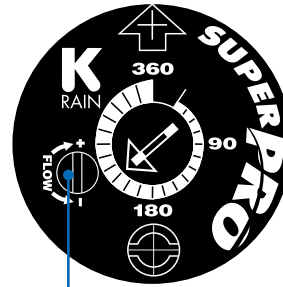

Intelligent Flow  
Technology®

- Reduces distance and flow rate simultaneously and proportionately up to 50%
- Provides full on/off control

## How to Specify with Options

MODEL	OPTION
10003	-CV Check valve
10003-HP	-NN No nozzle
10003-SH	-RCW Reclaimed water use
	-OS On-site wastewater applications

Examples: 10003-RCW-CV

## Low Angle Performance Data

NOZZLE	PRESSURE PSI	NO ADJUSTMENT				-30% ADJUSTMENT			
		RADIUS Feet	FLOW GPM	PRECIP in/hr ■ ▲		RADIUS Feet	FLOW GPM	PRECIP in/hr ■ ▲	
#1.0	30	26	1.1	.31	.36	18	0.8	.44	.51
	40	30	1.3	.28	.32	21	0.9	.40	.46
	50	30	1.4	.30	.35	21	1.0	.43	.50
	60	30	1.6	.34	.40	21	1.1	.49	.57
#1.5	30	27	1.4	.37	.43	19	1.0	.53	.61
	40	28	1.7	.42	.48	20	1.2	.60	.69
	50	31	1.9	.38	.44	22	1.3	.54	.63
	60	30	2.1	.45	.52	21	1.5	.64	.74
#2.0	30	30	2.1	.45	.52	21	1.5	.64	.74
	40	31	2.4	.48	.56	22	1.7	.69	.80
	50	33	2.8	.50	.57	23	2.0	.71	.81
	60	31	3.1	.62	.72	22	2.2	.89	1.03
#3.0	30	32	3.0	.56	.65	22	2.1	.80	.93
	40	34	3.5	.58	.67	24	2.5	.83	.96
	50	35	3.9	.61	.71	25	2.7	.87	1.01
	60	35	4.3	.68	.78	25	3.0	.97	1.11

\*All precipitation rates calculated for 180° operation.  
For the precipitation rate for a 360° sprinkler, divide by 2.

## Accessories

See page 24-25



Watch the video. Scan this code  
with your smartphone camera.

## Performance Data, Metric

NOZZLE	NO ADJUSTMENT					-30% ADJUSTMENT				
	PRESSURE		RADIUS	FLOW	PRECIP mm/hr		RADIUS	FLOW	PRECIP mm/hr	
	kPa	Bar	Meters	L/M	■	▲	Meters	L/M	■	▲
#1.0	207	2,1	10,1	4,5	5	6	6,4	3,2	8	9
	276	2,8	10,1	4,9	6	7	6,6	3,4	8	10
	345	3,4	10,1	5,7	7	8	6,6	4,0	10	11
	414	4,1	10,1	6,8	8	9	6,8	4,8	12	13
#1.5	207	2,1	11,0	5,7	6	7	7,7	4,0	8	9
	276	2,8	11,3	6,8	6	7	7,9	4,8	9	11
	345	3,4	11,3	7,6	7	8	7,9	5,3	10	12
	414	4,1	11,6	8,3	7	9	8,1	5,8	11	12
#2.0	207	2,1	10,7	6,8	7	8	7,5	4,8	10	12
	276	2,8	10,7	8,3	9	10	7,5	5,8	13	15
	345	3,4	11,0	9,8	10	11	7,7	6,9	14	16
	414	4,1	11,6	11,0	10	11	8,1	7,7	14	16
#2.5 Pre- installed	207	2,1	11,3	9,5	9	10	7,9	6,6	13	15
	276	2,8	11,6	11,4	10	12	8,1	8,0	15	17
	345	3,4	12,2	12,9	10	12	8,5	9,0	15	17
	414	4,1	12,2	14,4	12	13	8,5	10,1	17	19
#3.0	207	2,1	11,0	11,4	11	13	7,7	8,0	16	19
	276	2,8	11,3	12,9	12	14	7,9	9,0	17	20
	345	3,4	11,6	15,1	13	16	8,1	10,6	19	22
	414	4,1	12,5	16,7	13	15	8,8	11,7	18	21
#4.0	207	2,1	11,3	15,1	14	17	7,9	10,6	20	24
	276	2,8	11,9	17,0	14	17	8,3	11,9	21	24
	345	3,4	11,9	19,7	17	19	8,3	13,8	24	28
	414	4,1	12,2	21,2	17	20	8,5	14,9	24	28
#5.0	207	2,1	11,3	18,2	17	20	7,9	12,7	25	28
	276	2,8	11,6	21,2	19	22	8,1	14,9	27	31
	345	3,4	12,5	24,6	19	22	8,8	17,2	27	31
	414	4,1	13,1	27,3	19	22	9,2	19,1	27	32
#6.0	207	2,1	12,2	22,7	18	21	8,5	15,9	26	30
	276	2,8	12,5	25,7	20	23	8,8	18,0	28	33
	345	3,4	12,8	28,4	21	24	9,0	19,9	30	34
	414	4,1	13,4	31,8	21	24	9,4	22,3	30	35
#8.0	207	2,1	11,6	29,9	27	31	8,1	21,0	38	44
	276	2,8	13,4	34,8	23	27	9,4	24,4	33	38
	345	3,4	13,7	39,4	25	29	9,6	27,6	36	41
	414	4,1	14,0	42,0	26	30	9,8	29,4	37	42

## Low Angle Performance Data, Metric

NOZZLE	NO ADJUSTMENT					-30% ADJUSTMENT				
	PRESSURE		RADIUS	FLOW	PRECIP mm/hr		RADIUS	FLOW	PRECIP mm/hr	
	kPa	Bar	Meters	L/M	■	▲	Meters	L/M	■	▲
#1.0	207	2,1	7,9	4,2	8	9	5,6	2,9	11	13
	276	2,8	9,1	4,9	7	8	6,4	3,4	10	12
	345	3,4	9,1	5,3	8	9	6,4	3,7	11	13
	414	4,1	9,1	6,1	9	10	6,4	4,2	12	15
#1.5	207	2,1	8,2	5,3	9	11	5,8	3,7	13	16
	276	2,8	8,5	6,4	11	12	6,0	4,5	15	17
	345	3,4	9,4	7,2	10	11	6,6	5,0	14	16
	414	4,1	9,1	7,9	11	13	6,4	5,6	16	19
#2.0	207	2,1	9,1	7,9	11	13	6,4	5,6	16	19
	276	2,8	9,4	9,1	12	14	6,6	6,4	17	20
	345	3,4	10,1	10,6	13	14	7,0	7,4	18	21
	414	4,1	9,4	11,7	16	18	6,6	8,2	22	26
#3.0	207	2,1	9,8	11,4	14	17	6,8	8,0	20	24
	276	2,8	10,4	13,2	15	17	7,3	9,3	21	24
	345	3,4	10,7	14,8	15	18	7,5	10,3	22	26
	414	4,1	10,7	16,3	17	20	7,5	11,4	25	28

\*All precipitation rates calculated for 180° operation.  
For the precipitation rate for a 360° sprinkler, divide by 2.





Watch the video. Scan this code with your smartphone camera.



# ProSport®

Designed for sports turf and commercial applications.

## Features

- Patented Top Arc Set – Allows for wet or dry adjustment in seconds
- Triple Nozzle Configuration – Ensures even distribution of water
- Arc adjustment from 40° to a continuous 360°
- Top Arc Set Degree Markings – Clearly indicates the current watering pattern and simplifies arc set adjustment
- Arc Memory Clutch – Prevents internal gear damage and returns rotor to its prior setting automatically if nozzle turret is forced past stop
- Patented Reversing Mechanism – Assures continuous reverse and return
- Heavy Duty Rubber Cover and Mud Guard – Protects against physical injury and allows sprinkler to be installed below grade
- Factory Installed Check Valve – Prevents low head drainage

## Specifications

- Arc Adjustment Range: 40° to Continuous 360°
- Flow Range: 5.1 – 32.5 GPM (19,3 – 123 LPM)
- Pressure Rating: 40 – 90 PSI (2,8 – 6,2 bar)
- Precipitation Rate: .48 – 1.56 in/hr (12,2 – 39,6 mm/hr) (depending on spacing and nozzle used)
- Recommended Spacing: 40' – 65' (12,2 – 19,8 m)
- Radius: 43' – 77' (13,1 – 23,5 m)
- Nozzle Trajectory: 26°

## Model

<b>14003</b>	ProSport® Plastic
<b>14003-6INCH</b>	ProSport® 6 inch
<b>14053</b>	ProSport® High Speed Plastic
<b>14053-6INCH</b>	ProSport® High Speed Plastic 6 inch

## Easy Arc Setting

Arc Selection: 40° to continuous 360°  
Adjust from left start

## Accessories

See page 24-25









## Fast Facts

<b>ALL</b>	Inlet: 1" (2,5 cm) female thread NPT
<b>4"</b>	Retracted height: 7 1/2" (19 cm) Riser height: 4 1/2" (11,4 cm)
<b>6"</b>	Retracted height: 12" (30,5 cm) Riser height: 6 1/4" (15,9 cm)

















### 14003 Performance Data

NOZZLE	PRESSURE PSI	RADIUS Feet	FLOW GPM	PRECIP in/hr	
				■	▲
	40	45	5.1	.48	.58
	50	47	5.9	.51	.62
	60	47	6.5	.57	.68
	70	49	7.1	.57	.68
	50	53	10.6	.73	.87
	60	53	11.8	.81	.97
	70	53	12.6	.86	1.04
	80	55	13.5	.86	1.03
	50	57	13.0	.77	.92
	60	59	14.2	.79	.94
	70	59	15.4	.85	1.02
	80	63	16.5	.80	.96
	60	65	18.9	.86	1.03
	70	67	20.5	.88	1.06
	80	69	21.9	.89	1.06
	90	71	23.2	.89	1.06
	60	67	22.8	.98	1.17
	70	71	24.8	.95	1.14
	80	75	26.5	.91	1.09
	90	77	26.8	.87	1.04
	60	67	23.7	1.02	1.22
	70	69	25.6	1.04	1.24
	80	69	27.5	1.11	1.33
	90	71	29.2	1.12	1.34







### 14003 Performance Data, Metric

NOZZLE	PRESSURE Bar	RADIUS Meters	FLOW L/M	PRECIP mm/hr	
				■	▲
	2,8	13,7	19,3	12	15
	3,5	14,3	22,3	13	16
	4,1	14,3	24,6	14	17
	4,8	14,9	26,9	14	17
	3,5	16,2	40,1	18	22
	4,1	16,2	44,7	21	25
	4,8	16,2	47,7	22	26
	5,5	16,8	51,1	22	26
	3,5	17,4	49,2	20	23
	4,1	18,0	53,8	20	24
	4,8	18,0	58,3	22	26
	5,5	19,2	62,5	20	24
	4,1	19,8	71,5	22	26
	4,8	20,4	77,6	22	27
	5,5	21,0	82,9	23	27
	6,2	21,6	87,8	23	27
	4,1	20,4	86,3	25	30
	4,8	21,6	93,9	24	29
	5,5	22,9	100,3	23	28
	6,2	23,5	101,4	22	26
	4,1	20,4	89,7	26	31
	4,8	21,0	96,9	26	31
	6,2	21,0	104,1	28	34
	6,2	21,6	110,5	28	34

### 14053 Performance Data

NOZZLE	PRESSURE PSI	RADIUS Feet	FLOW GPM	PRECIP in/hr	
				■	▲
	40	43	5.9	.61	.71
	50	44	6.2	.62	.71
	60	45	6.4	.61	.70
	70	45	7.6	.72	.83
	50	49	10.6	.85	.98
	60	53	11.5	.79	.91
	70	53	13.3	.91	1.05
	80	54	14.0	.92	1.07
	50	52	12.4	.88	1.02
	60	54	13.6	.90	1.04
	70	56	14.6	.90	1.03
	80	58	15.9	.91	1.05
	60	56	19.8	1.22	1.40
	70	58	21.2	1.21	1.40
	80	59	22.8	1.26	1.46
	90	60	24.4	1.30	1.51
	60	59	22.4	1.24	1.43
	70	66	25.7	1.14	1.31
	80	67	27.8	1.19	1.38
	90	68	29.9	1.24	1.44
	60	60	25.2	1.35	1.56
	70	72	28.5	1.06	1.22
	80	73	30.8	1.11	1.28
	90	75	32.5	1.11	1.28

### 14053 Performance Data, Metric

NOZZLE	PRESSURE Bar	RADIUS Meters	FLOW L/M	PRECIP mm/hr	
				■	▲
	2,8	13,1	22,3	15	18
	3,5	13,4	23,5	16	18
	4,1	13,7	24,2	15	18
	4,8	13,7	28,8	18	21
	3,5	14,9	40,1	22	25
	4,1	15,8	44,3	20	23
	4,8	16,1	50,3	23	27
	5,5	16,5	53,0	23	27
	3,5	15,8	46,9	22	26
	4,1	16,5	55,3	23	26
	4,8	17,1	58,7	23	26
	5,5	17,1	60,2	23	27
	4,1	17,1	66,2	31	36
	4,8	17,7	71,5	31	36
	5,5	18,0	78,7	32	37
	6,2	18,3	82,1	33	38
	4,1	18,0	84,8	31	36
	4,8	20,1	97,3	29	33
	5,5	20,4	105,2	30	35
	6,2	20,7	113,2	31	37
	4,1	18,3	95,4	34	40
	4,8	22,0	107,9	27	31
	6,2	22,2	116,6	28	33
	6,2	22,9	123,0	28	33

\*All precipitation rates calculated for 180° operation. For the precipitation rate for a 360° sprinkler, divide by 2.

### How to Specify with Options

MODEL	OPTION
14003	-SS Stainless steel (4" only)
14003-6INCH	-BSP with BSP thread
14053	-RCW Reclaimed water use

Examples: 14003-BSP, 14053-RCW-NN

Visit our Sport  
Field Designs.



Watch the video. Scan this code  
with your smartphone camera.

# Rotor Accessories

## Nozzle Racks

- P52775** MiniPro® and RPS 50 Nozzle Rack (red)
- P51399** ProPlus® Nozzle Rack (red)  
Standard: 0.5, 0.75, 1, 2, 3, 4, 6, 8 GPM  
Low Angle: 1, 3, 4, 6 GPM  
Pre-installed Nozzle: 2.5 GPM
- P16001101** RPS™ 75 Nozzle Rack (red)  
Standard: 0.75, 1, 1.5, 2, 4, 6, 8 GPM  
Low Angle: 1, 3, 4, 6 GPM  
Pre-installed Nozzle: 3.0 GPM
- P90001102** ProPlus-RCW low angle nozzle rack
- P16001110** RPS™ 75i, SuperPro Nozzle Rack (green)  
Standard: 1, 1.5, 2, 2.5, 3, 4, 5, 6, 8 GPM  
Low Angle: 1, 1.5, 2, 3 GPM  
Pre-installed Nozzle: 2.5 GPM

## ProSport®

- P14055130** Nozzle Pack (1 nozzle of each)
- P55519** 5 GPM (18,9 LPM), white (12 count)  
10 GPM (37,9 LPM), green (12 count)  
15 GPM (56,8 LPM), grey (12 count)  
20 GPM (75,7 LPM), brown (12 count)  
25 GPM (94,6 LPM), blue (12 count)  
30 GPM (113,5 LPM), black (12 count)

## How to Specify Nozzle

MODEL	OPTION
55519	-5

Example: P55519-5, P55519-10

## Adjustment Tools

- P59995** K-Key; MiniPro®, ProPlus® Adjustment Key
- P1000902** SuperPro®, RPS™ Select, ProSport® Adjustment Key
- P1000901** RPS™ 75, RPS™ 75i, RPS™ 50 Adjustment Key
- RN-ADJ-TOOL** Rotary Nozzle Adjustment Tool

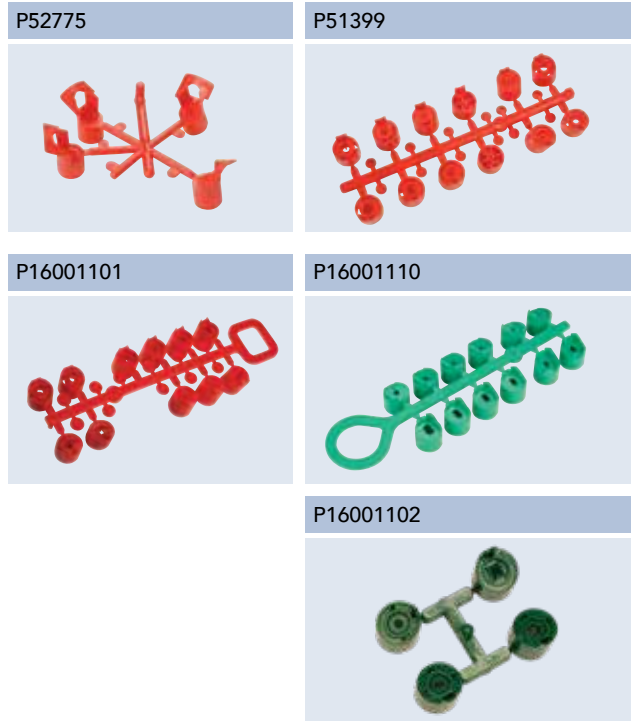

## Riser Clips, Check Valves and Filter Baskets

<b>P54065</b>	Riser Clip
<b>P51210</b>	SuperPro®-HP, SuperPro®-SH, RPS™ Select-SH, RPS™ 75-SH, RPS™ 75i-SH, ProPlus® High Pop and ProPlus® Shrub Check Valve*
<b>P513995</b>	MiniPro®, RPS™ 50 Check Valve
<b>P16009110</b>	RPS™ 75, 75i, Select, ProPlus®, SuperPro® Check Valve Assembly
<b>P53425</b>	ProSport® Check Valve*
<b>P51114</b>	MiniPro® Filter Basket
<b>P51115</b>	RPS™ 75, 75i, Select Filter Basket
<b>P51112</b>	SuperPro® High Pop, ProPlus® High Pop Filter Basket*
<b>P58115</b>	ProPlus®, SuperPro® Filter Basket

\*Also for use with ProPlus® and SuperPro® rotors in-ground before October 2019.

## Swing Pipe & Fittings

<b>KA05100</b>	Swing Pipe, 1/2" x 100' Roll
<b>SWPC050</b>	Swing Pipe, Coupling, 1/2" Barb
<b>SWPT050</b>	Swing Pipe, Tee, 1/2" Barb
<b>SWPE050</b>	Swing Pipe, Elbow, 1/2" MNPT x 1/2" Barb
<b>SWPE075</b>	Swing Pipe, Elbow, 3/4" MNPT x 1/2" Barb
<b>SWPA060505</b>	Swing Pipe Assembly, 6in, 1/2" Inlet x 1/2" Outlet
<b>SWPA120505</b>	Swing Pipe Assembly, 12in, 1/2" Inlet x 1/2" Outlet
<b>SWPA127575</b>	Swing Pipe Assembly, 12in, 3/4" Inlet x 3/4" Outlet
<b>SWPA180505</b>	Swing Pipe Assembly, 18in, 1/2" Inlet x 1/2" Outlet

**KA05100**

**SWPC050**

**SWPT050**

**SWPE050**

**SWPE075**

**SWPA127575**

# sprays



## Spray Body Comparison Chart

The perfect combination of precise engineering and extensive field testing ensures long life and outstanding performance with every K-Rain spray. Well-suited for any application, the sprays are rugged, reliable and available in a wide selection of sizes for optimal flexibility.

Model	PRO-S SPRAYS					NP SPRAYS		K-SPRAYS			
	78002	78003	78004	78006	78012	NP2	NP4	73001	74001	76001	71201
<b>Specifications</b>											
Pop-up height	1 1/2"	2 1/2"	3 1/2"	5 1/2"	11 1/2"	2"	3 7/8"	2 1/2"	4"	5 7/8"	11 1/2"
Retracted height	4 3/8"	5"	6"	9 3/8"	16"	4"	6"	4 3/4"	5 7/8"	8"	15 3/4"
Pressure range (PSI)	20-110	20-110	20-110	20-110	20-110	20-70	20-70	20-70	20-70	20-70	20-70
Inlet	1/2" female thread	1/2" female thread	1/2" female thread	1/2" female thread	1/2" female thread	1/2" female thread	1/2" female thread	1/2" female thread	1/2" female thread	1/2" female thread	1/2" female thread
Nozzle	female threaded	female threaded	female threaded	female threaded	female threaded	female threaded	female threaded	male threaded	male threaded	male threaded	male threaded
<b>Features</b>											
Co-molded wiper seal	•	•	•	•	•						
Ratcheting riser	•	•	•	•	•	•	•	•	•	•	•
Heavy duty retraction spring	•	•	•	•	•	•	•	•	•	•	•
Side inlet				★	•						•
Narrow profile						•	•				
Warranty	7 years	7 years	7 years	7 years	7 years	7 years	7 years	7 years	7 years	7 years	7 years
<b>Options</b>											
Check valve	•	•	•	•	•	•	•	•	•	•	•
Nozzle guard	•	•	•	•	•						
Pressure regulator (30 PSI)			•	•	•						
Pressure regulator (40 PSI)			•	•	•						
Reclaimed water use	•	•	•	•	•			•	•	•	•
Stop Flow™			•								

\*No side inlet option available.

# PRO-S™ Sprays

Proven long life and outstanding performance.

sprays

## Features

- Co-molded wiper seal — Ensures a leak-free, full pop-up even under low pressure situations. Treated with UV inhibitors for long life. Carefully selected seal material reduces degradation and stick-ups
- Heavy-duty retraction spring — Strongest in the industry for complete retraction in all soil conditions
- Pre-installed flush cap
- Accepts female threaded nozzles
- Fits in Rain Bird® 1800 can

## Specifications

- Pressure rating: 20 – 110 PSI (1,4 – 7,6 bar)
- Flow-by: 0 – 8 PSI (0,6 bar) 0.20 GPM (0,76 LPM)
- Inlet: 1/2" (1,3 cm) Female Thread NPT

## Models

- 78002** Pro-S 2" (5 cm) Pop-up
- 78003** Pro-S 3" (7,5 cm) Pop-up
- 78004** Pro-S 4" (10 cm) Pop-up
- 78006** Pro-S 6" (15 cm) Pop-up with side inlet
- 78012** Pro-S 12" (30 cm) Pop-up

## Accessories

See page 32

## Fast Facts

All	Inlet: 1/2" (1,3 cm) female thread NPT
2"	Retracted height: 4 3/8" (11,1 cm) Riser height: 1 1/2" (3,8 cm)
3"	Retracted height: 5" (12,7 cm) Riser height: 2 1/2" (6,4 cm)
4"	Retracted height: 6" (15,2) Riser height: 3 1/2" (8,9 cm)
6"	Retracted height: 9 3/8" (23,8 cm) Riser height: 5 1/2" (14,0 cm)
12"	Retracted height: 16" (40,6 cm) Riser height: 11 1/2" (29,2 cm)



## Options

- In-stem Pressure Regulator**  
 Factory preset at 30 or 40 PSI (2,1 or 2,8 bar). Available in 4", 6" and 12". EPA WaterSense certified. Visit [krain.com/watersense-certified](http://krain.com/watersense-certified) for a full list.



- In-stem Check Valve**  
 Pre-installed or installs in the field. Holds up to 10' (3 m) of head pressure.



- Pre-installed Nozzle Guard**  
 Protects the nozzle from foot traffic, mowers, edgers and arc changes.



- Stop Flow™**  
 Automatically stops water flow should the nozzle become damaged or removed.

Stop Flow™ valve



## How to Specify with Options

MODEL	OPTION	
78002	- CV	Check valve
78003	- GUARD	Nozzle guard
78004	- NSI	No side inlet (6" only)
78006	- PR30	Pressure regulator 30 PSI
78012	- PR40	Pressure regulator 40 PSI
	- RCW	Reclaimed water use
	- SF	Stop Flow™ 4" only

Examples: 78004-CV, 78006-NSI-RCW, 78012-CV-PR30



Watch the videos. Scan these codes with your smartphone camera.



Pro-S Spray



Pro-S Spray with Stop Flow

# NP Sprays

Ideal for watering smaller lawns, ground cover and shrub areas.

## Features

- Available in 2" and 4" (5 cm and 10 cm) Models – Provides flexibility in system design
- Accepts Female Threaded Nozzles
- Stainless Steel Retraction Spring – Provides reliable retraction of the riser in all soil conditions
- Ratcheting Riser – Allows for easy pattern alignment by turning the riser
- Narrow Profile Body – Easy to retrofit with existing systems

## Specifications

- Pressure Rating: 20 – 70 PSI (1,4 – 4,8 bar)
- Inlet: 1/2" (1,3 cm) female thread NPT

## Models

- NP2** 2" (5 cm) Narrow Profile Spray Body
- NP4** 4" (10 cm) Narrow Profile Spray Body

## Fast Facts

All	Inlet: 1/2" (1,3 cm) female thread NPT
NP2	Retracted height: 4" (10,2 cm) Riser height: 2" (5,1 cm)
NP4	Retracted height: 6" (15,2 cm) Riser height: 3 7/8" (9,8 cm)

## How to Specify with Options

MODEL	OPTION
NP2	-CV Check valve
NP4	

Example: NP4-CV

## Accessories

See page 32





A wide range of pop-up heights suited for many applications.

sprays

## Features

- Available in 3", 4", 6" and 12" Models – Provides flexibility in system design
- Accepts Male Threaded Nozzles
- Stainless Steel Retraction Spring – Provides reliable retraction of the riser in all soil conditions
- Ratcheting Riser – Allows for easy pattern alignment by turning the riser
- Heavy Duty Wiper Seal – Ensures leak free, full pop-up operation even under low-pressure situations
- Optional Water-Saving Check Valve – Eliminates low head drainage
- Optional Purple Cap for Reclaimed Water Use – Highly visible for identification of RCW systems

## Fast Facts

All	Inlet: 1/2" (1,3 cm) female thread NPT
73001	Retracted height: 4 3/4" (12,1 cm) Riser height: 2 1/2" (6,4 cm)
74001	Retracted height: 5 7/8" (14,9 cm) Riser height: 4" (10,2 cm)
76001	Retracted height: 8" (20,3 cm) Riser height: 5 7/8" (14,9 cm)
71201	Retracted height: 15 3/4" (40 cm) Riser height: 11 1/2" (29,2 cm)

## Specifications

- Pressure Rating: 20 – 70 PSI (1,4 – 4,8 bar)
- Inlet: 1/2" (1,3 cm) female thread NPT

## Models

- 73001 3" (7,6 cm) Pop-Up
- 74001 4" (10 cm) Pop-Up
- 76001 6" (15 cm) Pop-Up
- 71201 12" (30,5 cm) Pop-Up

## How to Specify with Options

MODEL	OPTION
73001	-CV Check valve
74001	-RCW Reclaimed water use
76001	
71201	

Examples: 73001-CV, 71201-RCW

## Accessories

See page 32



# Spray Accessories

## Models

### SHRUB ADAPTERS

- PSA** Shrub Adapter, Female Thread (for male nozzles)
- PFSA** Shrub Adapter, Male Thread (for female nozzles)
- PSA-RCW** RCW Shrub adapter, Female Thread, (for male nozzles)
- PFSA-RCW** RCW Shrub adapter, Male Thread, (for female nozzles)



## Models

### CHECK DISKS

- P53426** K-Spray™ Check Valve
- P53428** Pro-S™ Check Valve
- P53429** NP Spray™ Check Valve



## Models

### NOZZLE GUARD

- 78000** Nozzle Guard  
(fits Pro-S™ Sprays)
- 78000-RCW** Nozzle Guard for Reclaimed Water\*  
(Does not include riser seal)



## Models

### SWING PIPE & FITTINGS

- KA05100** Swing Pipe, 1/2" x 100' Roll
- SWPC050** Swing Pipe, Coupling, 1/2" Barb
- SWPT050** Swing Pipe, Tee, 1/2" Barb
- SWPE050** Swing Pipe, Elbow, 1/2" MNPT x 1/2" Barb
- SWPE075** Swing Pipe, Elbow, 3/4" MNPT x 1/2" Barb
- SWPA060505** Swing Pipe Assembly, 6in,  
1/2" Inlet x 1/2" Outlet
- SWPA120505** Swing Pipe Assembly, 12in,  
1/2" Inlet x 1/2" Outlet
- SWPA127575** Swing Pipe Assembly, 12in,  
3/4" Inlet x 3/4" Outlet
- SWPA180505** Swing Pipe Assembly, 18in,  
1/2" Inlet x 1/2" Outlet

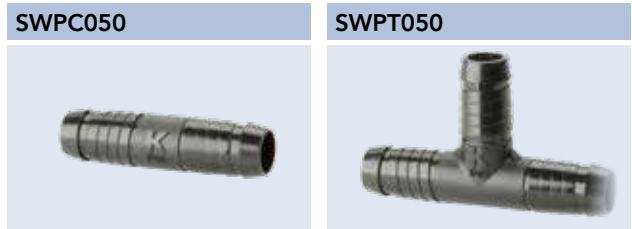

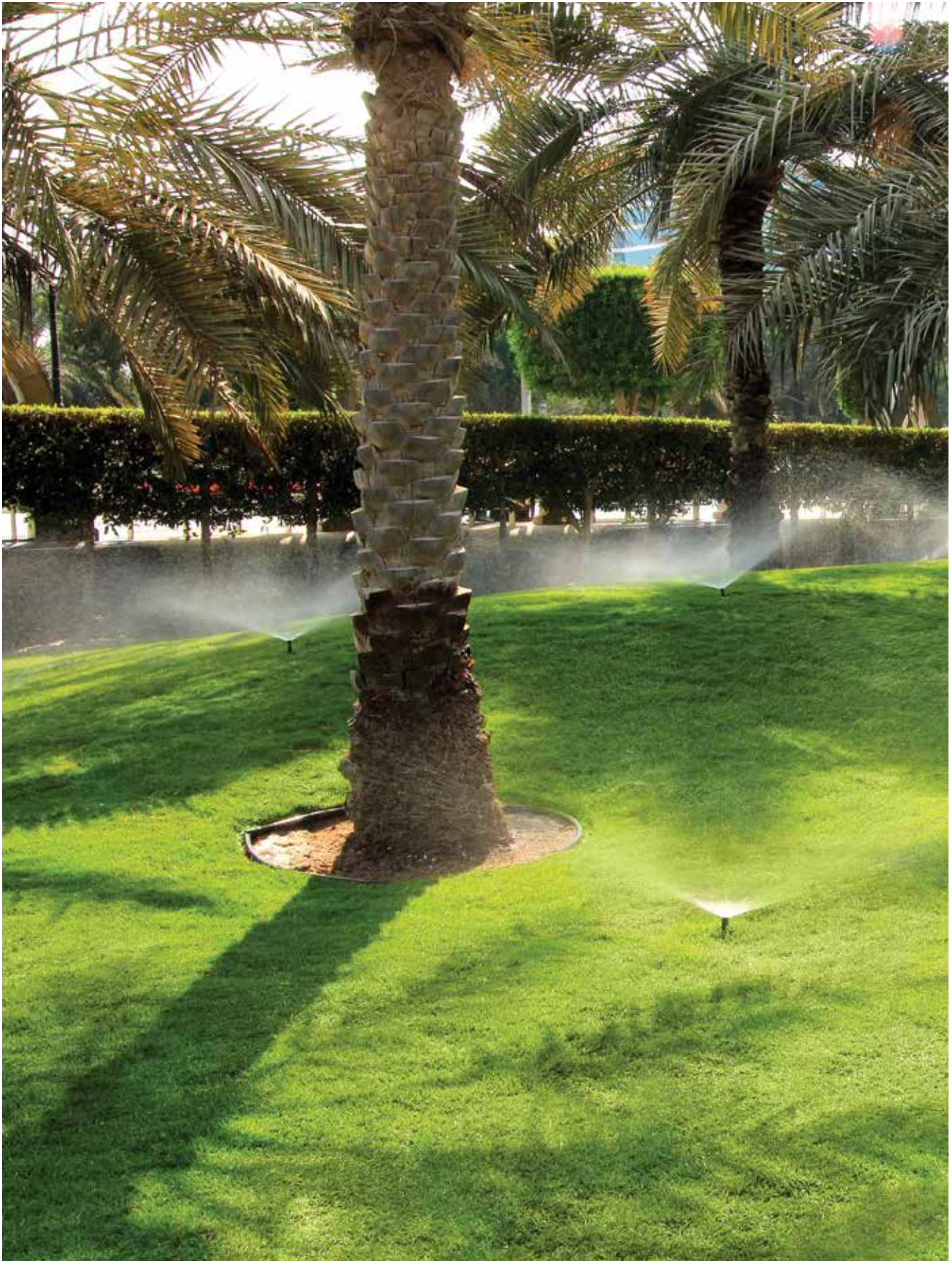

# nozzles



## Nozzle Comparison Chart

Designed with the utmost attention to detail, the versatility of the K-Rain nozzle line ensures that the professional has everything needed for a variety of residential and commercial terrains.

	Rotary Nozzle Series	Fully Adjustable Rotary Nozzle	KVF Adjustable Nozzles	KV Adjustable Nozzles	Fixed Pattern Nozzles
Nozzle Type	Full 360° Adjustable	Fully Adjustable	Fully Adjustable	Fully Adjustable	Fixed Spray
<b>Specifications</b>					
Arc	90° - 360°	80° - 360°	0° - 360°	0° - 360°	90° - 360°
Radius	13' - 30'	13' - 30'	6' - 18'	5' - 20'	6' - 17'
Thread	female	female	female	male	female & male
Special patterns	right, left & side strip				center, end, side & high/low strip
Special pattern dimensions	4' x 15' to 7' x 32'				4' x 12' to 15' x 5' x 32'
<b>Features</b>					
Color-coded	•	•	•	•	•
Automatic matched precipitation	•	•	•	•	
Warranty	3 year	3 year	7 year	7 year	7 year

\* At optimal pressure

nozzles

# Rotary Nozzle Series

Superior uniformity for demanding, low-precipitation applications.

## Features

- Durable Design – Molded with high-impact engineered resin for long life
- Superior Uniformity – Multi-stream technology provides outstanding coverage eliminating brown spots
- Matched Precipitation – Low precipitation rate is proportionate even after arc and radius adjustment
- Water-smart Technology – Reduce water usage up to 30% without compromising on results
- Double pop-up Design – Delivers additional protection from dirt/particulate intrusion in all conditions
- Simple to Adjust – Easiest adjustment in the industry
- Color-Coded – Easily identify 6 standard nozzles and 3 specialty nozzles in the field

Watch the video.  
Scan this code  
with your smart-  
phone camera.



## Models

### RN100-ADJ-90-270

90°-270° Adjustable

13' – 15' (4 – 4,6 m)

■ Medium Green

### RN100-FIX360

360° Fixed Pattern,

13' – 15' (4 – 4,6 m)

■ Light Green

### RN200-ADJ-90-270

90°-270° Adjustable,

16' – 19' (4,9 – 5,8 m)

■ Medium Blue

### RN200-FIX360

360° Fixed Pattern,

16' – 19' (4,9 – 5,8 m)

■ Light Blue

### RN300-ADJ-90-270

90°-270° Adjustable,

26' – 30' (7,9 – 9,1 m)

■ Medium Grey

### RN300-FIX360

360° Fixed Pattern,

26' – 30' (7,9 – 9,1 m)

■ Light Grey

### RNS-RES-515

Right End Strip,

■ Burnt Orange

### RNS-LES-515

Left End Strip,

■ Olive

### RNS-SS-530

Side Strip,

■ Brown

## Performance Data

RN100-ADJ-90-270 (medium green)

ARC DEGREE	PRESSURE PSI	RADIUS Feet	FLOW GPM	PRECIP in/hr	
				■	▲
90°	30	13	.22	.50	.58
	35	14	.24	.47	.54
	40	14	.25	.49	.57
	45	15	.28	.48	.55
	50	15	.30	.51	.59
180°	30	13	.44	.50	.58
	35	14	.47	.46	.53
	40	14	.50	.49	.57
	45	15	.58	.50	.57
	50	15	.60	.51	.59
270°	30	13	.66	.50	.58
	35	14	.71	.46	.54
	40	14	.75	.49	.57
	45	15	.88	.50	.58
	50	15	.90	.51	.59

## Performance Data

RN100-FIX360 (light green)

ARC DEGREE	PRESSURE PSI	RADIUS Feet	FLOW GPM	PRECIP in/hr	
				■	▲
360°	30	13	.88	.50	.58
	35	14	.94	.46	.53
	40	14	1.00	.49	.57
	45	15	1.15	.49	.57
	50	15	1.20	.51	.59

## Performance Data

RN200-ADJ-90-270 (medium blue)

ARC DEGREE	PRESSURE PSI	RADIUS Feet	FLOW GPM	PRECIP in/hr	
				■	▲
90°	30	16	.34	.51	.59
	35	17	.38	.51	.58
	40	18	.41	.49	.56
	45	19	.42	.45	.52
	50	19	.47	.50	.58
180°	30	16	.67	.50	.58
	35	17	.75	.50	.58
	40	18	.83	.49	.57
	45	19	.84	.45	.52
	50	19	.94	.50	.58
270°	30	16	1.01	.51	.58
	35	17	1.13	.50	.58
	40	18	1.24	.49	.57
	45	18	1.26	.50	.58
	50	19	1.41	.50	.58

## Performance Data

RN200-FIX360 (light blue)

ARC DEGREE	PRESSURE PSI	RADIUS Feet	FLOW GPM	PRECIP in/hr	
				■	▲
360°	30	16	1.34	.50	.58
	35	17	1.50	.50	.58
	40	18	1.65	.49	.57
	45	19	1.68	.45	.52
	50	19	1.88	.50	.58

## Performance Data, Metric

RN100-ADJ-90-270 (medium green)

ARC DEGREE	PRESSURE Bar	RADIUS Meters	FLOW L/M	PRECIP mm/hr	
				■	▲
90°	2,1	3,96	0,83	13	15
	2,4	4,27	0,91	12	14
	2,8	4,27	0,95	12	14
	3,1	4,57	1,06	12	14
	3,4	4,57	1,14	13	15
180°	2,1	3,96	1,67	13	15
	2,4	4,27	1,78	12	13
	2,8	4,27	1,89	12	14
	3,1	4,57	2,20	13	14
	3,4	4,57	2,27	13	15
270°	2,1	3,96	2,50	13	15
	2,4	4,27	2,69	12	14
	2,8	4,27	2,84	12	14
	3,1	4,57	3,33	13	15
	3,4	4,57	3,41	13	15

## Performance Data, Metric

RN100-FIX360 (light green)

ARC DEGREE	PRESSURE Bar	RADIUS Meters	FLOW L/M	PRECIP mm/hr	
				■	▲
360°	2,1	3,96	3,33	13	15
	2,4	4,27	3,56	12	13
	2,8	4,27	3,79	12	14
	3,1	4,57	4,35	12	14
	3,4	4,57	4,54	13	15

## Performance Data, Metric

RN200-ADJ-90-270 (medium blue)

ARC DEGREE	PRESSURE Bar	RADIUS Meters	FLOW L/M	PRECIP mm/hr	
				■	▲
90°	2,1	4,88	1,29	13	15
	2,4	5,18	1,44	13	15
	2,8	5,49	1,55	12	14
	3,1	5,79	1,59	11	13
	3,5	5,79	1,78	13	15
180°	2,1	4,88	2,54	13	15
	2,4	5,18	2,84	13	15
	2,8	5,49	3,14	12	14
	3,1	5,79	3,18	11	13
	3,4	5,79	3,56	13	15
270°	2,1	4,88	3,82	13	15
	2,4	5,18	4,28	13	15
	2,8	5,49	4,69	12	14
	3,1	5,49	4,77	13	15
	3,4	5,79	5,34	13	15

## Performance Data, Metric

RN200-FIX360 (light blue)

ARC DEGREE	PRESSURE Bar	RADIUS Meters	FLOW L/M	PRECIP mm/hr	
				■	▲
360°	2,1	4,88	5,07	13	15
	2,4	5,18	5,68	13	15
	2,8	5,49	6,25	12	14
	3,1	5,79	6,36	11	13
	3,4	5,79	7,12	13	15

\*Data represents test results in zero wind. Adjust for local conditions.

### Performance Data

RN300-ADJ-90-270 (medium grey)

ARC DEGREE	PRESSURE PSI	RADIUS Feet	FLOW GPM	PRECIP in/hr	
				■	▲
90°	30	26	.80	.46	.53
	35	26	.85	.48	.56
	40	27	.90	.48	.55
	45	28	.95	.47	.54
	50	28	1.00	.49	.57
180°	30	26	1.40	.40	.46
	35	27	1.50	.40	.46
	40	27	1.60	.42	.49
	45	29	1.70	.39	.45
	50	30	1.80	.39	.44
270°	30	26	2.45	.47	.54
	35	27	2.55	.45	.52
	40	28	2.75	.45	.52
	45	28	2.90	.47	.55
	50	27	3.10	.55	.63

### Performance Data, Metric

RN300-ADJ-90-270 (medium grey)

ARC DEGREE	PRESSURE Bar	RADIUS Meters	FLOW L/M	PRECIP mm/hr	
				■	▲
90°	2,1	7,92	3,03	12	13
	2,4	7,92	3,22	12	14
	2,8	8,23	3,41	12	14
	3,1	8,53	3,60	12	14
	3,4	8,53	3,79	12	14
180°	2,1	7,92	5,30	10	12
	2,4	8,23	5,68	10	12
	2,8	8,23	6,06	11	12
	3,1	8,84	6,44	10	11
	3,4	9,14	6,81	10	11
270°	2,1	7,92	9,27	12	14
	2,4	8,23	9,65	11	13
	2,8	8,53	10,41	11	13
	3,1	8,53	10,98	12	14
	3,4	8,23	11,73	14	16

### Performance Data

RN300-FIX360 (light grey)

ARC DEGREE	PRESSURE PSI	RADIUS Feet	FLOW GPM	PRECIP in/hr	
				■	▲
360°	30	26	3.10	.44	.51
	35	27	3.20	.42	.49
	40	28	3.50	.43	.50
	45	28	3.55	.44	.50
	50	30	3.70	.40	.46



### Performance Data, Metric

RN300-FIX360 (light grey)

ARC DEGREE	PRESSURE Bar	RADIUS Meters	FLOW L/M	PRECIP mm/hr	
				■	▲
360°	2,1	7,92	11,73	11	13
	2,4	8,23	12,11	11	12
	2,8	8,53	13,25	11	13
	3,1	8,53	13,44	11	13
	3,4	9,14	14,01	10	12



### Performance Data

Special Patterns

PATTERN	NOZZLE	PRESSURE PSI	W X L Feet	FLOW GPM
Right End Strip	RNS-RES-515	30	4 x 15	.30
	Burnt Orange	35	5 x 15	.32
		40	5 x 15	.35
		45	6 x 16	.38
		50	6 x 16	.40
Left End Strip	RNS-LES-515	30	4 x 15	.30
	Olive	35	5 x 15	.32
		40	5 x 15	.35
		45	6 x 15	.38
		50	6 x 16	.40
Side Strip	RNS-SS-530	30	4 x 29	.50
	Brown	35	5 x 30	.55
		40	5 x 30	.60
		45	6 x 31	.65
		50	7 x 32	.70

### Performance Data, Metric

Special Patterns

PATTERN	NOZZLE	PRESSURE Bar	W X L Meters	FLOW L/M
Right End Strip	RNS-RES-515	2,1	1,22 x 4,6	1,14
	Burnt Orange	2,4	1,5 x 4,6	1,21
		2,8	1,5 x 4,6	1,32
		3,1	1,8 x 4,9	1,43
		3,5	1,8 x 4,9	1,51
Left End Strip	RNS-LES-515	2,1	1,22 x 4,6	1,14
	Olive	2,4	1,5 x 4,6	1,21
		2,8	1,5 x 4,6	1,32
		3,1	1,8 x 4,6	1,43
		3,5	1,8 x 4,9	1,51
Side Strip	RNS-SS-530	2,1	1,22 x 8,8	1,80
	Brown	2,4	1,5 x 9,1	2,08
		2,8	1,5 x 9,1	2,30
		3,1	1,8 x 9,4	2,46
		3,5	2,1 x 9,7	2,64

\*Data represents test results in zero wind. Adjust for local conditions.



# Fully Adjustable Rotary Nozzle

The only fully adjustable rotary nozzle from 80° – 360°.

## Features

- Fully adjustable 80° to 360° – only one SKU per distance
- Female Threaded – replaces all female thread nozzles
- Hand adjustable – no tools needed
- Radius adjustment up to 30% – patented flow control
- Arc adjustment wet or dry – visual left start and right stop
- Double pop up system – superior dirt tolerance
- Three model options – distances from 13' to 30' (3,96 m to 9,14 m)
- Matched precipitation – superior efficiency in water and uniformity through all patterns and distances
- Low precipitation rate – reduces runoff and improves soil absorption
- Low flow rate – allows for more heads per zone, fewer zones
- Viscous dampening – ensures consistent application speed over varying flow rates and pressure ranges
- Multiple stream technology – for improved wind resistance
- Large filter – prolongs product life
- Can be installed in the same zone as rotors
- Three year limited warranty



## Models

### RN100-ADJ

80°-360° Adjustable  
13' – 15' (4 – 4,6 m),

 Green

### RN200-ADJ

80°-360° Adjustable  
16' – 19' (4,9 – 5,8 m),

 Blue

### RN300-ADJ

80°-360° Adjustable  
26' – 30' (7,9 – 9,1 m),

 Red



Watch the video.  
Scan this code  
with your smart-  
phone camera.



### Performance Data

RN100-ADJ (green)

ARC DEGREE	PRESSURE PSI	RADIUS Feet	FLOW GPM	PRECIP in/hr	
				■	▲
90°	30	13	.22	.50	.58
	40	14	.25	.49	.57
	50	15	.30	.51	.59
180°	30	13	.44	.50	.58
	40	14	.50	.49	.57
	50	15	.60	.51	.59
360°	30	13	.90	.51	.59
	40	14	1.00	.49	.57
	50	15	1.20	.51	.59

### Performance Data, Metric

RN100-ADJ (green)

ARC DEGREE	PRESSURE Bar	RADIUS Meters	FLOW L/M	PRECIP mm/hr	
				■	▲
90°	2,1	3,96	0,83	13	15
	2,8	4,27	0,95	12	14
	3,5	4,57	1,14	13	15
180°	2,1	3,96	1,67	13	15
	2,8	4,27	1,89	12	14
	3,5	4,57	2,27	13	15
360°	2,1	3,96	3,41	13	15
	2,8	4,27	3,79	12	14
	3,5	4,57	4,54	13	15

### Performance Data

RN200-ADJ (blue)

ARC DEGREE	PRESSURE PSI	RADIUS Feet	FLOW GPM	PRECIP in/hr	
				■	▲
90°	30	16	.34	.51	.59
	40	18	.41	.49	.56
	50	19	.47	.50	.58
180°	30	16	.67	.50	.58
	40	18	.83	.49	.57
	50	19	.94	.50	.58
360°	30	16	1.35	.51	.59
	40	18	1.70	.51	.58
	50	19	1.90	.51	.58

### Performance Data, Metric

RN200-ADJ (blue)

ARC DEGREE	PRESSURE Bar	RADIUS Meters	FLOW L/M	PRECIP mm/hr	
				■	▲
90°	2,1	4,88	1,29	13	15
	2,8	5,49	1,55	12	14
	3,5	5,79	1,78	13	15
180°	2,1	4,88	2,54	13	15
	2,8	5,49	3,14	12	14
	3,5	5,79	3,56	13	15
360°	2,1	4,88	5,11	13	15
	2,8	5,49	6,44	13	15
	3,5	5,79	7,19	13	15

### Performance Data

RN300-ADJ (red)

ARC DEGREE	PRESSURE PSI	RADIUS Feet	FLOW GPM	PRECIP in/hr	
				■	▲
90°	30	26	.80	.46	.53
	40	27	.90	.48	.55
	50	29	1.00	.46	.53
180°	30	26	1.50	.43	.49
	40	27	1.60	.42	.49
	50	29	1.80	.41	.48
360°	30	26	3.00	.43	.49
	40	27	3.20	.42	.49
	50	28	3.80	.47	.54

### Performance Data, Metric

RN300-ADJ (red)

ARC DEGREE	PRESSURE Bar	RADIUS Meters	FLOW L/M	PRECIP mm/hr	
				■	▲
90°	2,1	7,92	3,03	12	13
	2,8	8,23	3,41	12	14
	3,5	8,84	3,79	12	13
180°	2,1	7,92	5,68	11	12
	2,8	8,23	6,06	11	12
	3,5	8,84	6,81	10	12
360°	2,1	7,92	11,36	11	12
	2,8	8,23	12,11	11	12
	3,5	8,83	14,38	12	14

\*Data represents test results in zero wind. Adjust for local conditions.



# KVF Nozzles

Complete flexibility for working in a variety of terrains.

## Features

- Superior Spray Patterns
- Fits any male-thread spray body
- Color-coded for Easy Identification
- Uniform Water Distribution
- Water Efficient Low Flow Rates
- Extra Long Filters Extend Time Between Cleanings

## Performance Data

KVF6 6' (1,8 m) Nozzle (red)

ARC DEGREE	PRESSURE PSI	RADIUS Feet	FLOW GPM	PRECIP in/hr	
				■	▲
90°	20	5	.36	5.54	6.40
	25	5	.43	6.16	7.65
	<b>30</b>	<b>6</b>	<b>.50</b>	<b>5.35</b>	<b>6.17</b>
	40	6	.59	6.31	7.29
180°	20	5	.60	4.61	5.33
	25	5	.66	5.07	5.86
	<b>30</b>	<b>6</b>	<b>.74</b>	<b>3.95</b>	<b>4.56</b>
	40	6	.86	4.59	5.30
270°	20	5	.80	4.10	4.74
	25	5	.89	4.56	5.27
	<b>30</b>	<b>6</b>	<b>.97</b>	<b>3.45</b>	<b>3.99</b>
	40	6	1.20	4.27	4.93
360°	20	5	1.08	4.15	4.79
	25	5	1.25	4.81	5.55
	<b>30</b>	<b>6</b>	<b>1.37</b>	<b>3.66</b>	<b>4.22</b>
	40	6	1.62	4.33	4.99

## Performance Data, Metric

KVF6 6' (1,8 m) Nozzle (red)

ARC DEGREE	PRESSURE Bar	RADIUS Meters	FLOW L/M	PRECIP mm/hr	
				■	▲
90°	1,38	1,5	1,36	141	163
	1,72	1,5	1,63	156	194
	<b>2,07</b>	<b>1,8</b>	<b>1,89</b>	<b>136</b>	<b>157</b>
	2,76	1,8	2,23	160	185
180°	1,38	1,5	2,27	117	135
	1,72	1,5	2,50	129	149
	<b>2,07</b>	<b>1,8</b>	<b>2,80</b>	<b>100</b>	<b>116</b>
	2,76	1,8	3,26	117	135
270°	1,38	1,5	3,03	104	120
	1,72	1,5	3,37	116	134
	<b>2,07</b>	<b>1,8</b>	<b>3,67</b>	<b>88</b>	<b>101</b>
	2,76	1,8	4,54	108	125
360°	1,38	1,5	4,09	105	122
	1,72	1,5	4,73	122	141
	<b>2,07</b>	<b>1,8</b>	<b>5,19</b>	<b>93</b>	<b>107</b>
	2,76	1,8	6,13	110	127

## Performance Data

KVF8 8' (2,4 m) Nozzle (green)

ARC DEGREE	PRESSURE PSI	RADIUS Feet	FLOW GPM	PRECIP in/hr	
				■	▲
90°	20	9	.39	1.85	2.14
	25	10	.42	1.62	1.87
	<b>30</b>	<b>10</b>	<b>.50</b>	<b>1.93</b>	<b>2.22</b>
	40	11	.61	1.94	2.24
180°	20	9	.75	1.78	2.06
	25	9	.85	2.02	2.33
	<b>30</b>	<b>10</b>	<b>1.00</b>	<b>1.93</b>	<b>2.22</b>
	40	10	1.16	2.23	2.58
270°	20	9	1.15	1.82	2.10
	25	9	1.25	1.98	2.29
	<b>30</b>	<b>10</b>	<b>1.50</b>	<b>1.93</b>	<b>2.22</b>
	40	10	1.75	2.25	2.59
360°	20	9	1.50	1.78	2.06
	25	9	1.70	2.02	2.33
	<b>30</b>	<b>10</b>	<b>2.00</b>	<b>1.93</b>	<b>2.22</b>
	40	10	2.30	2.21	2.56

## Performance Data, Metric

KVF8 8' (2,4 m) Nozzle (green)

ARC DEGREE	PRESSURE Bar	RADIUS Meters	FLOW L/M	PRECIP mm/hr	
				■	▲
90°	1,38	2,7	1,48	47	54
	1,72	3,1	1,59	41	47
	<b>2,07</b>	<b>3,1</b>	<b>1,89</b>	<b>49</b>	<b>56</b>
	2,76	3,4	2,31	49	57
180°	1,38	2,7	2,84	45	52
	1,72	2,7	3,22	51	59
	<b>2,07</b>	<b>3,1</b>	<b>3,79</b>	<b>49</b>	<b>56</b>
	2,76	3,1	4,39	57	65
270°	1,38	2,7	4,35	46	53
	1,72	2,7	4,73	50	58
	<b>2,07</b>	<b>3,1</b>	<b>5,68</b>	<b>49</b>	<b>56</b>
	2,76	3,1	6,62	57	66
360°	1,38	2,7	5,68	45	52
	1,72	2,7	6,44	51	59
	<b>2,07</b>	<b>3,1</b>	<b>7,57</b>	<b>49</b>	<b>56</b>
	2,76	3,1	8,71	56	65

## Models

### KVF6

6' (1,8 m) Nozzle,  
■ Red

### KVF8

8' (2,4 m) Nozzle,  
■ Green

### KVF10

10' (3 m) Nozzle,  
■ Blue

### KVF12

12' (3,7 m) Nozzle,  
■ Brown

### KVF15

15' (4,6 m) Nozzle,  
■ Black

### KVF17

17' (5,2 m) Nozzle,  
■ Grey

## Performance Data

KVF10 10' (3 m) Nozzle (blue)

ARC DEGREE	PRESSURE PSI	RADIUS Feet	FLOW GPM	PRECIP in/hr	
				■	▲
90°	20	10	.45	1.73	2.00
	25	11	.54	1.72	1.98
	<b>30</b>	<b>12</b>	<b>.62</b>	<b>1.66</b>	<b>1.91</b>
	40	12	.70	1.87	2.16
180°	20	10	.90	1.73	2.00
	25	11	1.10	1.75	2.02
	<b>30</b>	<b>12</b>	<b>1.25</b>	<b>1.67</b>	<b>1.93</b>
	40	12	1.40	1.87	2.16
270°	20	10	1.35	1.73	2.00
	25	11	1.65	1.75	2.02
	<b>30</b>	<b>12</b>	<b>1.85</b>	<b>1.65</b>	<b>1.90</b>
	40	12	2.10	1.87	2.16
360°	20	10	1.80	1.73	2.00
	25	11	2.20	1.75	2.02
	<b>30</b>	<b>12</b>	<b>2.50</b>	<b>1.67</b>	<b>1.93</b>
	40	12	2.80	1.87	2.16

## Performance Data, Metric

KVF10 10' (3 m) Nozzle (blue)

ARC DEGREE	PRESSURE Bar	RADIUS Meters	FLOW L/M	PRECIP mm/hr	
				■	▲
90°	1,38	3,1	1,70	44	51
	1,72	3,4	2,04	44	50
	<b>2,07</b>	<b>3,7</b>	<b>2,35</b>	<b>42</b>	<b>49</b>
	2,76	3,7	2,65	47	55
180°	1,38	3,1	3,41	44	51
	1,72	3,4	4,16	44	51
	<b>2,07</b>	<b>3,7</b>	<b>4,73</b>	<b>42</b>	<b>49</b>
	2,76	3,7	5,30	47	55
270°	1,38	3,1	5,11	44	51
	1,72	3,4	6,25	44	51
	<b>2,07</b>	<b>3,7</b>	<b>7,00</b>	<b>42</b>	<b>48</b>
	2,76	3,7	7,95	47	55
360°	1,38	3,1	6,81	44	51
	1,72	3,4	8,33	44	51
	<b>2,07</b>	<b>3,7</b>	<b>9,46</b>	<b>42</b>	<b>49</b>
	2,76	3,7	10,60	47	55

\*Data represents test results in zero wind. Radius may be reduced with the radius reduction screw. **Bold = recommended pressure of 30 PSI**

### Performance Data

KVF12 12' (3,7 m) Nozzle (brown)

ARC DEGREE	PRESSURE PSI	RADIUS Feet	FLOW GPM	PRECIP in/hr	
				■	▲
90°	20	12	.65	1.74	2.01
	25	13	.70	1.59	1.84
	<b>30</b>	<b>14</b>	<b>.80</b>	<b>1.57</b>	<b>1.81</b>
	40	14	.90	1.77	2.04
180°	20	12	1.30	1.74	2.01
	25	13	1.40	1.59	1.84
	<b>30</b>	<b>14</b>	<b>1.60</b>	<b>1.57</b>	<b>1.81</b>
	40	14	1.80	1.77	2.04
270°	20	12	1.90	1.69	1.96
	25	13	2.10	1.59	1.84
	<b>30</b>	<b>14</b>	<b>2.40</b>	<b>1.57</b>	<b>1.81</b>
	40	14	2.60	1.70	1.97
360°	20	12	2.20	1.47	1.70
	25	13	2.60	1.48	1.71
	<b>30</b>	<b>14</b>	<b>3.10</b>	<b>1.52</b>	<b>1.76</b>
	40	14	3.50	1.72	1.98

### Performance Data, Metric

KVF12 12' (3,7 m) Nozzle (brown)

ARC DEGREE	PRESSURE Bar	RADIUS Meters	FLOW L/M	PRECIP mm/hr	
				■	▲
90°	1,38	3,7	2,46	44	51
	1,72	4,0	2,65	40	47
	<b>2,07</b>	<b>4,3</b>	<b>3,03</b>	<b>40</b>	<b>46</b>
	2,76	4,3	3,41	45	52
180°	1,38	3,7	4,92	44	51
	1,72	4,0	5,30	40	47
	<b>2,07</b>	<b>4,3</b>	<b>6,06</b>	<b>40</b>	<b>46</b>
	2,76	4,3	6,81	45	52
270°	1,38	3,7	7,19	43	50
	1,72	4,0	7,95	40	47
	<b>2,07</b>	<b>4,3</b>	<b>9,08</b>	<b>40</b>	<b>46</b>
	2,76	4,3	9,84	43	50
360°	1,38	3,7	8,33	37	43
	1,72	4,0	9,84	38	43
	<b>2,07</b>	<b>4,3</b>	<b>11,73</b>	<b>39</b>	<b>45</b>
	2,76	4,3	13,25	44	50

### Performance Data

KVF15 15' (4,6 m) Nozzle (black)

ARC DEGREE	PRESSURE PSI	RADIUS Feet	FLOW GPM	PRECIP in/hr	
				■	▲
90°	20	14	.75	1.47	1.70
	25	15	.85	1.45	1.68
	<b>30</b>	<b>15</b>	<b>.95</b>	<b>1.63</b>	<b>1.88</b>
	40	17	1.10	1.47	1.69
180°	20	14	1.40	1.38	1.59
	25	15	1.70	1.45	1.68
	<b>30</b>	<b>15</b>	<b>1.90</b>	<b>1.63</b>	<b>1.88</b>
	40	17	2.30	1.53	1.77
270°	20	14	2.25	1.47	1.70
	25	15	2.55	1.45	1.68
	<b>30</b>	<b>15</b>	<b>2.80</b>	<b>1.60</b>	<b>1.84</b>
	40	17	3.40	1.51	1.74
360°	20	14	3.00	1.47	1.70
	25	15	3.40	1.45	1.68
	<b>30</b>	<b>15</b>	<b>3.80</b>	<b>1.63</b>	<b>1.88</b>
	40	17	4.60	1.53	1.77

### Performance Data, Metric

KVF15 15' (4,6 m) Nozzle (black)

ARC DEGREE	PRESSURE Bar	RADIUS Meters	FLOW L/M	PRECIP mm/hr	
				■	▲
90°	1,38	4,3	2,84	37	43
	1,72	4,6	3,22	37	43
	<b>2,07</b>	<b>4,6</b>	<b>3,60</b>	<b>41</b>	<b>48</b>
	2,76	5,2	4,16	37	43
180°	1,38	4,3	5,30	35	40
	1,72	4,6	6,44	37	43
	<b>2,07</b>	<b>4,6</b>	<b>7,19</b>	<b>41</b>	<b>48</b>
	2,76	5,2	8,71	39	45
270°	1,38	4,3	8,52	37	43
	1,72	4,6	9,65	37	43
	<b>2,07</b>	<b>4,6</b>	<b>10,60</b>	<b>41</b>	<b>47</b>
	2,76	5,2	12,87	38	44
360°	1,38	4,3	11,36	37	43
	1,72	4,6	12,87	37	43
	<b>2,07</b>	<b>4,6</b>	<b>14,38</b>	<b>41</b>	<b>48</b>
	2,76	5,2	17,41	39	45

### Performance Data

KVF17 17' (5,2 m) Nozzle (grey)

ARC DEGREE	PRESSURE PSI	RADIUS Feet	FLOW GPM	PRECIP in/hr	
				■	▲
90°	20	17	.85	1.13	1.31
	25	17	.95	1.27	1.46
	<b>30</b>	<b>18</b>	<b>1.05</b>	<b>1.25</b>	<b>1.44</b>
	40	18	1.20	1.43	1.65
180°	20	16	1.70	1.28	1.48
	25	17	1.90	1.27	1.46
	<b>30</b>	<b>18</b>	<b>2.10</b>	<b>1.25</b>	<b>1.44</b>
	40	18	2.40	1.43	1.65
270°	20	16	2.50	1.25	1.45
	25	17	2.80	1.24	1.44
	<b>30</b>	<b>18</b>	<b>3.15</b>	<b>1.25</b>	<b>1.44</b>
	40	18	3.60	1.43	1.65
360°	20	16	3.40	1.28	1.48
	25	17	3.80	1.27	1.46
	<b>30</b>	<b>18</b>	<b>4.20</b>	<b>1.25</b>	<b>1.44</b>
	40	18	4.80	1.43	1.65

### Performance Data, Metric

KVF17 17' (5,2 m) Nozzle (grey)

ARC DEGREE	PRESSURE Bar	RADIUS Meters	FLOW L/M	PRECIP mm/hr	
				■	▲
90°	1,38	5,2	3,22	29	33
	1,72	5,2	3,60	32	37
	<b>2,07</b>	<b>5,5</b>	<b>3,97</b>	<b>32</b>	<b>37</b>
	2,76	5,5	4,54	36	42
180°	1,38	4,9	6,44	32	37
	1,72	5,2	7,19	32	37
	<b>2,07</b>	<b>5,5</b>	<b>7,95</b>	<b>32</b>	<b>37</b>
	2,76	5,5	9,08	36	42
270°	1,38	4,9	9,46	32	37
	1,72	5,2	10,60	32	36
	<b>2,07</b>	<b>5,5</b>	<b>11,92</b>	<b>32</b>	<b>37</b>
	2,76	5,5	13,63	36	42
360°	1,38	4,9	12,87	32	37
	1,72	5,2	14,38	32	37
	<b>2,07</b>	<b>5,5</b>	<b>15,90</b>	<b>32</b>	<b>37</b>
	2,76	5,5	18,17	36	42



nozzles

\*Data represents test results in zero wind. Radius may be reduced with the radius reduction screw. **Bold = recommended pressure of 30 PSI.**

# KV Nozzles

Adjustable pattern, male-threaded nozzles.

## Features

- Superior Spray Patterns
- Fits K-Rain® K-Spray™ bodies
- Color-coded for Easy Identification
- Extra Long Filters Extend Time Between Cleanings

## Models

### KV8

8' (2,4 m) Nozzle,  
■ Green

### KV10

10' (3 m) Nozzle,  
■ Blue

### KV12

12' (3,7 m) Nozzle,  
■ Brown

### KV15

15' (4,6 m) Nozzle,  
■ Black

### KV17

17' (5,2 m) Nozzle,  
■ Grey

## Performance Data

KV8 8' (2,4 m) Nozzle (Green)

ARC DEGREE	PRESSURE PSI	RADIUS Feet	FLOW GPM	PRECIP in/hr	
				■	▲
90°	20	7	.30	2.36	2.72
	<b>30</b>	<b>8</b>	<b>.40</b>	<b>2.41</b>	<b>2.78</b>
	40	8	.40	2.41	2.78
	50	9	.40	1.90	2.20
180°	20	7	.80	3.14	3.63
	<b>30</b>	<b>8</b>	<b>.90</b>	<b>2.71</b>	<b>3.13</b>
	40	8	1.00	3.01	3.47
	50	9	1.10	2.61	3.02
270°	20	7	1.20	3.14	3.63
	<b>30</b>	<b>8</b>	<b>1.20</b>	<b>2.41</b>	<b>2.78</b>
	40	8	1.30	2.61	3.01
	50	9	1.50	2.38	2.74
360°	20	7	1.90	3.73	4.31
	<b>30</b>	<b>8</b>	<b>2.00</b>	<b>3.01</b>	<b>3.47</b>
	40	8	2.20	3.31	3.82
	50	9	2.30	2.73	3.16

## Performance Data, Metric

KV8 8' (2,4 m) Nozzle (Green)

ARC DEGREE	PRESSURE Bar	RADIUS Meters	FLOW L/M	PRECIP mm/hr	
				■	▲
90°	1,38	2,1	1,14	60	69
	<b>2,07</b>	<b>2,4</b>	<b>1,51</b>	<b>61</b>	<b>70</b>
	2,76	2,4	1,51	61	70
	3,45	2,7	1,51	48	56
180°	1,38	2,1	3,03	80	92
	<b>2,07</b>	<b>2,4</b>	<b>3,41</b>	<b>69</b>	<b>79</b>
	2,76	2,4	3,79	76	88
	3,45	2,7	4,16	66	77
270°	1,38	2,1	4,54	80	92
	<b>2,07</b>	<b>2,4</b>	<b>4,54</b>	<b>61</b>	<b>70</b>
	2,76	2,4	4,92	66	76
	3,45	2,7	5,68	60	70
360°	1,38	2,1	7,19	95	109
	<b>2,07</b>	<b>2,4</b>	<b>7,57</b>	<b>76</b>	<b>88</b>
	2,76	2,4	8,33	84	97
	3,45	2,7	8,71	69	80

## Performance Data

KV10 10' (3 m) Nozzle (Blue)

ARC DEGREE	PRESSURE PSI	RADIUS Feet	FLOW GPM	PRECIP in/hr	
				■	▲
90°	20	12	.70	1.87	2.16
	<b>30</b>	<b>12</b>	<b>1.10</b>	<b>2.94</b>	<b>3.40</b>
	40	13	1.40	3.19	3.68
	50	14	1.50	2.95	3.40
180°	20	11	1.40	2.23	2.57
	<b>30</b>	<b>11</b>	<b>1.60</b>	<b>2.55</b>	<b>2.94</b>
	40	12	1.80	2.41	2.78
	50	13	2.00	2.28	2.63
270°	20	10	1.70	2.18	2.52
	<b>30</b>	<b>10</b>	<b>2.00</b>	<b>2.57</b>	<b>2.96</b>
	40	11	2.30	2.44	2.82
	50	12	2.60	2.32	2.68
360°	20	10	2.20	2.12	2.45
	<b>30</b>	<b>10</b>	<b>2.70</b>	<b>2.60</b>	<b>3.00</b>
	40	11	3.00	2.39	2.76
	50	12	3.50	2.34	2.70

## Performance Data, Metric

KV10 10' (3 m) Nozzle (Blue)

ARC DEGREE	PRESSURE Bar	RADIUS Meters	FLOW L/M	PRECIP mm/hr	
				■	▲
90°	1,38	3,7	2,65	47	55
	<b>2,07</b>	<b>3,7</b>	<b>4,16</b>	<b>75</b>	<b>86</b>
	2,76	4,0	5,30	81	93
	3,45	4,3	5,68	75	86
180°	1,38	3,4	5,30	56	65
	<b>2,07</b>	<b>3,4</b>	<b>6,06</b>	<b>65</b>	<b>75</b>
	2,76	3,7	6,81	61	70
	3,45	4,0	7,57	58	67
270°	1,38	3,1	6,44	55	64
	<b>2,07</b>	<b>3,1</b>	<b>7,57</b>	<b>65</b>	<b>75</b>
	2,76	3,4	8,71	62	71
	3,45	3,7	9,84	59	68
360°	1,38	3,1	8,33	54	62
	<b>2,07</b>	<b>3,1</b>	<b>10,22</b>	<b>66</b>	<b>76</b>
	2,76	3,4	11,36	61	70
	3,45	3,7	13,25	59	69

## Performance Data

KV12 12' (3,7 m) Nozzle (Brown)

ARC DEGREE	PRESSURE PSI	RADIUS Feet	FLOW GPM	PRECIP in/hr	
				■	▲
90°	20	12	1.10	2.94	3.40
	<b>30</b>	<b>13</b>	<b>1.30</b>	<b>2.96</b>	<b>3.42</b>
	40	14	1.50	2.95	3.40
	50	15	1.70	2.91	3.36
180°	20	11	1.60	2.55	2.94
	<b>30</b>	<b>12</b>	<b>1.80</b>	<b>2.41</b>	<b>2.78</b>
	40	13	2.20	2.51	2.89
	50	14	2.40	2.36	2.72
270°	20	11	1.90	2.02	2.33
	<b>30</b>	<b>12</b>	<b>2.40</b>	<b>2.14</b>	<b>2.47</b>
	40	12	2.60	2.32	2.68
	50	13	3.20	2.43	2.81
360°	20	11	2.80	2.23	2.57
	<b>30</b>	<b>12</b>	<b>3.10</b>	<b>2.07</b>	<b>2.39</b>
	40	12	3.50	2.34	2.70
	50	13	3.90	2.22	2.56

## Performance Data, Metric

KV12 12' (3,7 m) Nozzle (Brown)

ARC DEGREE	PRESSURE Bar	RADIUS Meters	FLOW L/M	PRECIP mm/hr	
				■	▲
90°	1,38	3,7	4,16	75	86
	<b>2,07</b>	<b>4,0</b>	<b>4,92</b>	<b>75</b>	<b>87</b>
	2,76	4,3	5,68	75	86
	3,45	4,6	6,44	74	85
180°	1,38	3,4	6,06	65	75
	<b>2,07</b>	<b>3,7</b>	<b>6,81</b>	<b>61</b>	<b>70</b>
	2,76	4,0	8,33	64	73
	3,45	4,3	9,08	60	69
270°	1,38	3,4	7,19	51	59
	<b>2,07</b>	<b>3,7</b>	<b>9,08</b>	<b>54</b>	<b>63</b>
	2,76	3,7	9,84	59	68
	3,45	4,0	12,11	62	71
360°	1,38	3,4	10,60	56	65
	<b>2,07</b>	<b>3,7</b>	<b>11,73</b>	<b>53</b>	<b>61</b>
	2,76	3,7	13,25	59	69
	3,45	4,0	14,76	56	65

\*Data represents test results in zero wind. Radius may be reduced with the radius reduction screw. **Bold = recommended pressure of 30 PSI.**

### Performance Data

KV15 15' (4,6 m) Nozzle (Black)

ARC DEGREE	PRESSURE PSI	RADIUS Feet	FLOW GPM	PRECIP in/hr	
				■	▲
90°	20	15	1.30	2.22	2.57
	<b>30</b>	<b>17</b>	<b>1.60</b>	<b>2.13</b>	<b>2.46</b>
	40	18	1.80	2.14	2.47
	50	19	2.00	2.13	2.46
180°	20	14	1.80	1.77	2.04
	<b>30</b>	<b>15</b>	<b>2.30</b>	<b>1.97</b>	<b>2.27</b>
	40	16	2.60	1.96	2.26
	50	18	2.80	1.66	1.92
270°	20	14	2.70	1.77	2.04
	<b>30</b>	<b>15</b>	<b>3.20</b>	<b>1.83</b>	<b>2.11</b>
	40	16	3.60	1.80	2.08
	50	18	4.00	1.58	1.83
360°	20	14	3.40	1.67	1.93
	<b>30</b>	<b>15</b>	<b>4.20</b>	<b>1.80</b>	<b>2.07</b>
	40	16	4.70	1.77	2.04
	50	16	5.30	1.99	2.30

### Performance Data, Metric

KV15 15' (4,6 m) Nozzle (Black)

ARC DEGREE	PRESSURE Bar	RADIUS Meters	FLOW L/M	PRECIP mm/hr	
				■	▲
90°	1,38	4,6	4,92	56	65
	<b>2,07</b>	<b>5,2</b>	<b>6,06</b>	<b>54</b>	<b>62</b>
	2,76	5,5	6,81	54	63
	3,45	5,8	7,57	54	62
180°	1,38	4,3	6,81	45	52
	<b>2,07</b>	<b>4,6</b>	<b>8,71</b>	<b>50</b>	<b>58</b>
	2,76	4,9	9,84	50	57
	3,45	5,5	10,60	42	49
270°	1,38	4,3	10,22	45	52
	<b>2,07</b>	<b>4,6</b>	<b>12,11</b>	<b>46</b>	<b>53</b>
	2,76	4,9	13,63	46	53
	3,45	5,5	15,14	40	46
360°	1,38	4,3	12,87	42	49
	<b>2,07</b>	<b>4,6</b>	<b>15,90</b>	<b>46</b>	<b>53</b>
	2,76	4,9	17,79	45	52
	3,45	4,9	20,06	51	58

nozzles

### Performance Data

KV17 17' (5,2 m) Nozzle (Grey)

ARC DEGREE	PRESSURE PSI	RADIUS Feet	FLOW GPM	PRECIP in/hr	
				■	▲
90°	20	18	1.70	2.02	2.33
	<b>30</b>	<b>18</b>	<b>1.80</b>	<b>2.14</b>	<b>2.47</b>
	40	19	2.00	2.13	2.46
	50	20	2.20	2.12	2.45
180°	20	17	1.90	1.27	1.46
	<b>30</b>	<b>18</b>	<b>2.40</b>	<b>1.43</b>	<b>1.65</b>
	40	19	2.60	1.39	1.60
	50	19	2.90	1.55	1.79
270°	20	16	2.90	1.45	1.68
	<b>30</b>	<b>17</b>	<b>3.40</b>	<b>1.51</b>	<b>1.74</b>
	40	18	4.00	1.58	1.83
	50	18	4.50	1.78	2.06
360°	20	15	3.50	1.50	1.73
	<b>30</b>	<b>17</b>	<b>4.40</b>	<b>1.47</b>	<b>1.69</b>
	40	17	4.90	1.63	1.88
	50	18	5.40	1.60	1.85

### Performance Data, Metric

KV17 17' (5,2 m) Nozzle (Grey)

ARC DEGREE	PRESSURE Bar	RADIUS Meters	FLOW L/M	PRECIP mm/hr	
				■	▲
90°	1,38	5,5	6,44	51	59
	<b>2,07</b>	<b>5,5</b>	<b>6,81</b>	<b>54</b>	<b>63</b>
	2,76	5,8	7,57	54	62
	3,45	6,1	8,33	54	62
180°	1,38	5,2	7,19	32	37
	<b>2,07</b>	<b>5,5</b>	<b>9,08</b>	<b>36</b>	<b>42</b>
	2,76	5,8	9,84	35	41
	3,45	5,8	10,98	39	45
270°	1,38	4,9	10,98	37	43
	<b>2,07</b>	<b>5,2</b>	<b>12,87</b>	<b>38</b>	<b>44</b>
	2,76	5,5	15,14	40	46
	3,45	5,5	17,03	45	52
360°	1,38	4,6	13,25	38	44
	<b>2,07</b>	<b>5,2</b>	<b>16,66</b>	<b>37</b>	<b>43</b>
	2,76	5,2	18,55	41	48
	3,45	5,5	20,44	41	47

\*Data represents test results in zero wind. Radius may be reduced with the radius reduction screw. **Bold = recommended pressure of 30 PSI.**



# Fixed Pattern Nozzles

Male-threaded, female-threaded and special patterns for system flexibility.

## Features

- Four distances plus eight fixed patterns provide an array of system configurations
- Color-coded for easy identification

## Models

### FN-8

8' (2,4 m) Female Nozzle, Green

### FN-10

10' (3,0 m) Female Nozzle, Blue

### FN-12

12' (3,7 m) Female Nozzle, Brown

### FN-15

15' (4,6 m) Female Nozzle, Black

### FN-15CS

Center Strip, Female

### FN-15ES

End Strip, Female

### FN-15SS

Side Strip, Female

### FN-15HL

High Low, Female

### P12

12' (3,7 M) Male Nozzle, Brown

### P15

15' (4,6 m) Male Nozzle, Black

### P15CS

Center Strip, Male

### P15ES

End Strip, Male

### P15SS





Side Strip, Male

### P15HL

High Low, Male





## Performance Data

FN-8 8' (2,4 m) Nozzle, Female (green)

NOZZLE/ PATTERN	PRESSURE PSI	RADIUS Feet	FLOW GPM	PRECIP in/hr	
				■	▲
90° FN-8Q 	20	6	.21	2.25	2.59
	25	7	.24	1.89	2.18
	30	8	.26	1.56	1.81
180° FN-8H 	20	6	.42	2.25	2.59
	25	7	.47	1.85	2.13
	30	8	.52	1.56	1.81
270° FN-8TQ 	20	6	.63	2.25	2.59
	25	7	.71	1.86	2.15
	30	8	.78	1.56	1.81
360° FN-8F 	20	6	.86	2.30	2.66
	25	7	.96	1.89	2.18
	30	8	1.05	1.58	1.82





## Performance Data

FN-10 10' (3 m) Nozzle, Female (blue)

NOZZLE/ PATTERN	PRESSURE PSI	RADIUS Feet	FLOW GPM	PRECIP in/hr	
				■	▲
90° FN10Q 	20	8	.33	1.99	2.29
	25	9	.36	1.71	1.98
	30	10	.39	1.50	1.73
180° FN10H 	20	8	.65	1.96	2.26
	25	9	.72	1.71	1.98
	30	10	.79	1.52	1.76
270° FN10TQ 	20	8	.98	1.97	2.27
	25	9	1.08	1.71	1.98
	30	10	1.18	1.51	1.75
360° FN10F 	20	8	1.03	1.55	1.79
	25	9	1.44	1.71	1.98
	30	10	1.58	1.52	1.76





## Performance Data

FN-12 12' (3,7 m) Nozzle, Female (brown)

NOZZLE/ PATTERN	PRESSURE PSI	RADIUS Feet	FLOW GPM	PRECIP in/hr	
				■	▲
90° FN-12Q 	20	10	.53	2.04	2.36
	25	11	.60	1.91	2.20
	30	12	.65	1.74	2.01
180° FN-12H 	20	10	1.05	2.02	2.33
	25	11	1.20	1.91	2.20
	30	12	1.30	1.74	2.01
270° FN-12TQ 	20	10	1.58	2.03	2.34
	25	11	1.80	1.91	2.20
	30	12	1.95	1.74	2.01
360° FN-12F 	20	10	2.10	2.02	2.33
	25	12	2.40	1.91	2.20
	30	12	2.60	1.74	2.01

## Performance Data





FN-15 15' (4,6 m) Nozzle, Female (black)

NOZZLE/ PATTERN	PRESSURE PSI	RADIUS Feet	FLOW GPM	PRECIP in/hr	
				■	▲
90° FN-15Q 	20	12	.75	2.01	2.32
	25	14	.82	1.61	1.86
	30	15	.92	1.57	1.82
180° FN-15H 	20	12	1.50	2.01	2.32
	25	14	1.65	1.62	1.87
	30	15	1.85	1.58	1.83
270° FN-15TQ 	20	12	2.25	2.01	2.32
	25	14	2.48	1.62	1.88
	30	15	2.78	1.59	1.83
360° FN-15F 	20	12	3.00	2.01	2.32
	25	14	3.30	1.62	1.87
	30	15	3.70	1.58	1.83

\*Data represents test results in zero wind. Radius may be reduced with the radius reduction screw. **Bold = recommended pressure of 30 PSI.**





## Performance Data, Metric

FN-8 8' (2,4 m) Nozzle, Female (green)

NOZZLE/ PATTERN	PRESSURE Bar	RADIUS Meters	FLOW L/M	PRECIP mm/hr	
				■	▲
90° FN-8Q 	1,4	1,8	0,80	57	66
	1,7	2,1	0,90	48	55
	2,1	2,4	1,00	40	46
180° FN-8H 	1,4	1,8	1,60	57	66
	1,7	2,1	1,80	47	54
	2,1	2,4	2,00	40	46
270° FN-8TQ 	1,4	1,8	2,40	57	66
	1,7	2,1	2,70	47	54
	2,1	2,4	3,00	40	46
360° FN8F 	1,4	1,8	3,30	58	67
	1,7	2,1	3,60	48	55
	2,1	2,4	4,00	40	46





## Performance Data, Metric

FN-10 10' (3 m) Nozzle, Female (blue)

NOZZLE/ PATTERN	PRESSURE Bar	RADIUS Meters	FLOW L/M	PRECIP mm/hr	
				■	▲
90° FN-10Q 	1,4	2,4	1,20	50	58
	1,7	2,7	1,40	43	50
	2,1	3,1	1,50	38	44
180° FN-10H 	1,4	2,4	2,50	50	57
	1,7	2,7	2,70	43	50
	2,1	3,1	3,00	39	45
270° FN-10TQ 	1,4	2,4	3,70	50	58
	1,7	2,7	4,10	43	50
	2,1	3,1	4,50	38	44
360° FN-10F 	1,4	2,4	3,90	39	45
	1,7	2,7	5,50	43	50
	2,1	3,1	6,00	39	45





## Performance Data, Metric

FN-12 12' (3,7 m) Nozzle, Female (brown)

NOZZLE/ PATTERN	PRESSURE Bar	RADIUS Meters	FLOW L/M	PRECIP mm/hr	
				■	▲
90° FN-12Q 	1,4	3,1	1,51	52	60
	1,7	3,4	1,70	48	56
	2,1	3,7	2,27	44	51
180° FN-12H 	1,4	3,1	2,27	51	59
	1,7	3,4	3,03	48	56
	2,1	3,7	3,79	44	51
270° FN-12TQ 	1,4	3,1	3,60	51	59
	1,7	3,4	3,79	48	56
	2,1	3,7	4,92	44	51
360° FN-12F 	1,4	3,1	6,06	51	59
	1,7	3,4	6,81	48	56
	2,1	3,7	7,95	44	51

## Performance Data, Metric

FN-15 15' (4,6 m) Nozzle, Female (black)

NOZZLE/ PATTERN	PRESSURE Bar	RADIUS Meters	FLOW L/M	PRECIP mm/hr	
				■	▲
90° FN-15Q 	1,4	3,7	2,80	51	59
	1,7	4,3	3,10	41	47
	2,1	4,6	3,50	40	46
180° FN-15H 	1,4	3,7	5,70	51	59
	1,7	4,3	6,20	41	47
	2,1	4,6	7,00	40	46
270° FN-15TQ 	1,4	3,7	8,50	51	59
	1,7	4,3	9,40	41	48
	2,1	4,6	10,5	40	46
360° FN-15F 	1,4	3,7	11,4	51	59
	1,7	4,3	12,5	41	47
	2,1	4,6	14,0	40	46

### Performance Data

P12 12' (3,7 m) Nozzle, Male (brown)

NOZZLE/ PATTERN	PRESSURE PSI	RADIUS Feet	FLOW GPM	PRECIP in/hr	
				■	▲
90° P12Q 	20	11	.40	1.27	1.47
	25	12	.45	1.20	1.39
	<b>30</b>	<b>13</b>	<b>.50</b>	<b>1.13</b>	<b>1.36</b>
	40	14	.60	1.18	1.38
180° P12H 	20	11	.60	.95	1.10
	25	12	.80	1.07	1.23
	<b>30</b>	<b>13</b>	<b>.80</b>	<b>.91</b>	<b>1.13</b>
	40	14	1.00	.98	1.19
270° P12TQ 	20	11	.95	1.01	1.16
	25	12	1.00	.89	1.03
	<b>30</b>	<b>13</b>	<b>1.10</b>	<b>.84</b>	<b>.98</b>
	40	14	1.30	.85	.95
360° P12F 	20	11	1.60	1.27	1.47
	25	12	1.80	1.20	1.39
	<b>30</b>	<b>13</b>	<b>1.90</b>	<b>1.08</b>	<b>1.36</b>
	40	14	2.10	1.18	1.38

### Performance Data, Metric

P12 12' (3,7 m) Nozzle, Male (brown)

NOZZLE/ PATTERN	PRESSURE Bar	RADIUS Meters	FLOW L/M	PRECIP mm/hr	
				■	▲
90° P12Q 	1,4	3,4	1,51	32	37
	1,7	3,7	1,70	30	35
	<b>2,8</b>	<b>4,3</b>	<b>2,27</b>	<b>30</b>	<b>35</b>
	3,4	4,6	2,65	30	35
180° P12H 	1,4	3,4	2,27	24	28
	1,7	3,7	3,03	27	31
	<b>2,8</b>	<b>4,3</b>	<b>3,79</b>	<b>25</b>	<b>29</b>
	3,4	4,6	4,54	26	30
270° P12TQ 	1,4	3,4	3,60	26	29
	1,7	3,7	3,79	23	26
	<b>2,8</b>	<b>4,3</b>	<b>4,92</b>	<b>22</b>	<b>25</b>
	3,4	4,6	5,49	21	24
360° P12F 	1,4	3,4	6,06	32	37
	1,7	3,7	6,81	30	35
	<b>2,8</b>	<b>4,3</b>	<b>7,95</b>	<b>30</b>	<b>35</b>
	3,4	4,6	10,6	30	35

### Performance Data

P15 15' (4,6 m) Nozzle, Male (black)

NOZZLE/ PATTERN	PRESSURE PSI	RADIUS Feet	FLOW GPM	PRECIP in/hr	
				■	▲
90° P15Q 	20	13	.60	1.37	1.58
	25	14	.75	1.47	1.70
	<b>30</b>	<b>16</b>	<b>.90</b>	<b>1.35</b>	<b>1.56</b>
	40	17	1.10	1.47	1.69
180° P15H 	20	13	1.20	1.37	1.58
	25	14	1.35	1.33	1.53
	<b>30</b>	<b>16</b>	<b>1.60</b>	<b>1.20</b>	<b>1.39</b>
	40	17	1.90	1.27	1.46
270° P15TQ 	20	13	1.85	1.40	1.62
	25	14	2.10	1.37	1.59
	<b>30</b>	<b>16</b>	<b>2.70</b>	<b>1.35</b>	<b>1.56</b>
	40	17	3.10	1.38	1.59
360° P15F 	20	13	2.80	1.56	1.84
	25	14	3.20	1.57	1.81
	<b>30</b>	<b>16</b>	<b>4.20</b>	<b>1.58</b>	<b>1.82</b>
	40	17	4.60	1.30	1.77

### Performance Data, Metric

P15 15' (4,6 m) Nozzle, Male (black)

NOZZLE/ PATTERN	PRESSURE Bar	RADIUS Meters	FLOW L/M	PRECIP mm/hr	
				■	▲
90° P15Q 	1,4	4,0	2,27	35	40
	1,7	4,3	2,84	37	43
	<b>2,8</b>	<b>4,9</b>	<b>3,41</b>	<b>34</b>	<b>40</b>
	3,4	5,2	4,16	37	43
180° P15H 	1,4	4,0	4,54	35	40
	1,7	4,3	5,11	34	39
	<b>2,8</b>	<b>4,9</b>	<b>6,06</b>	<b>30</b>	<b>35</b>
	3,4	5,2	7,19	32	37
270° P15TQ 	1,4	3,4	7,00	36	41
	1,7	4,3	7,95	35	40
	<b>2,8</b>	<b>4,9</b>	<b>10,22</b>	<b>34</b>	<b>40</b>
	3,4	5,2	11,73	35	40
360° P15F 	1,4	3,4	10,60	40	47
	1,7	4,3	12,11	40	46
	<b>2,8</b>	<b>4,9</b>	<b>15,90</b>	<b>40</b>	<b>46</b>
	3,4	5,2	17,41	33	45

### Performance Data

Special Patterns

NOZZLE/ PATTERN	NOZZLE		PRESSURE PSI	W X L Feet	FLOW GPM
	Male#	Female#			
Center Strip 	P15CS	FN-15CS	20	4 x 24	0.8
		30	4 x 30	1.0	
End Strip 	P15ES	FN-15ES	20	4 x 12	0.4
		30	4 x 15	0.5	
Side Strip 	P15SS	FN-15SS	20	4 x 28	1.1
		30	5 x 32	1.3	
High Low 	P15HL	FN-5HL	20	High: 14 x 28	2.5
			30	Low: 4 x 28	2.5
			30	High: 15 x 32	3.0
			30	Low: 5 x 32	3.0

### Performance Data, Metric

Special Patterns

NOZZLE/ PATTERN	NOZZLE		PRESSURE Bar	W X L Meters	FLOW L/M
	Male#	Female#			
Center Strip 	P15CS	FN-15CS	1,5	1,2 x 7,3	3,0
		2,0	1,2 x 9,1	3,8	
End Strip 	P15ES	FN-15ES	1,5	1,2 x 3,7	1,5
		2,0	1,2 x 4,6	1,9	
Side Strip 	P15SS	FN-15SS	1,5	1,2 x 8,5	4,2
		2,0	1,5 x 9,8	4,9	
High Low 	P15HL	FN-15HL	1,5	High: 4,3 x 8,5	9,5
			2,0	Low: 1,2 x 8,5	9,5
			2,0	High: 4,6 x 9,8	11,4
			2,0	Low: 1,5 x 9,8	11,4



\*Data represents test results in zero wind. Radius may be reduced with the radius reduction screw. **Bold = recommended pressure of 30 PSI.**

# Drip Irrigation

Efficient and trouble-free operation for non-turf areas.

## Features

- Install Above or Below Grade
- Dripline:
  - Pressure-compensating Emitters – Ensure uniform output across the entire length of run
  - In-line Emitter Check Valves – Prevents drainage from the dripline when water pressure drops below 2.5 PSI, protecting against the siphoning of small sediment and soil particles into the drip emitter – ideal for sub-surface installation
  - Available in Two Flow Rates and 2 spacing sizes – Provides maximum design flexibility in a variety of applications
- Drip Control Zone Kit – Pre-assembled for quick installation, heavy duty, corrosion resistant, 150 mesh stainless steel filter

## Specifications

- Flow rates: .58 GPH (2,3 L/H) color code - orange, 1 GPH (3,8 L/H) color code - gray
- Operating pressure: 12 – 50 PSI (0,8 – 3,5 bar)
- Check valve sealing pressure: 2.5 PSI (0,17 bar)
- Check valve opening pressure: 4.3 PSI (0,3 bar)
- Dripline color: brown
- Size: 1/2" (.570" ID x .670" OD) (14,5 mm ID x 17 mm OD)
- Spacing: 12" or 18" (30,5 cm or 45,7 cm)
- Minimum bending radius: 1' (0,3 m)
- Filter requirement: minimum of 150 mesh

### DRIP CONTROL ZONE KIT

- Pressure regulation 30 or 40 PSI (2,1 or 2,8 bar)
- Flow: 1 – 35 GPM (1,9 – 94,6 LPM)
- Operating pressure: 10 – 120 PSI (0,7 – 8,3 bar)
- Solenoid: 24V AC
- Inlet: 1" (2,5 cm) female thread NPT
- Outlet: 1" (2,5 cm) female thread NPT
- Dimensions: Height: 6 1/2" (16,5 cm), Width: 3" (7,6 cm), Length: 14 1/2" (36,8 cm)

## Models

- KA5-112P-CV** .67" (17 mm) .58 GPH (2,2 LPH), 100' (30,5 m) CV drip line coil w/12" (0,30 m) spacing, .57" ID x .67" OD (14,5 mm ID x 17 mm OD), brown
- KA5-212P-CV** .67" (17 mm) .58 GPH (2,2 LPH), 250' (76,2 m) CV drip line coil w/12" (0,30 m) spacing, .57" ID x .67" OD (14,5 mm ID x 17 mm OD), brown
- KA5-512P-CV** .67" (17 mm) .58 GPH (2,2 LPH), 500' (152,4 m) CV drip line coil w/12" (0,30 m) spacing, .57" ID x .67" OD (14,5 mm ID x 17 mm OD), brown
- KA5-2112P-CV** .67" (17 mm) 1.00 GPH (3,8 LPH), 100' (30,5 m) CV drip line coil w/ 12" (0,30 m) spacing, .57" ID x .67" OD (14,5 mm ID x 17 mm OD), brown
- KA5-2212P-CV** .67" (17 mm) 1.00 GPH (3,8 LPH), 250' (76,2 m) CV drip line coil w/ 12" (0,30 m) spacing, .57" ID x .67" OD (14,5 mm ID x 17 mm OD), brown
- KA5-2512P-CV** .67" (17 mm) 1.00 GPH (3,8 LPH), , 500' (152,4 m) CV drip line coil w/ 12" (0,30 m) spacing, .57" ID x .67" OD (14,5 mm ID x 17 mm OD), brown
- KA1-118P-CV** .67" (17 mm) 1 GPH (3,8 LPH), 100' (30,5 m) CV drip line coil w/18" (0,45 m) spacing, .57" ID x .67" OD (14,5 mm ID x 17 mm OD), brown
- KA1-218P-CV** .67" (17 mm) 1 GPH (3,8 LPH), 250' (76,2 m) CV drip line coil w/18" (0,45 m) spacing, .57" ID x .67" OD (14,5 mm ID x 17 mm OD), brown
- KA1-518P-CV** .67" (17 mm) 1.00 GPH (3,8 LPH), 500' (152,4 m) CV drip line coil w/ 18" (0,45 m) spacing, .57" ID x .67" OD (14,5 mm ID x 17 mm OD), brown
- K15-040** .67" (17 mm) barb coupling
- K15-041** .67" (17 mm) tee
- K15-042** .67" (17 mm) elbow
- K15-043** .67" (17 mm) barb x 1/2" (1,27 cm) NPT Tee
- K15-046** .67" (17 mm) barb x 1/2" (1,27 cm) NPT Adapter
- K18-028** 1/2" (1,27 cm) Air/Vacuum Relief Valve
- KP11-155** 3/4" (1,9 cm) plastic filter with 155 m stainless steel screen & flush cap
- KP11-374** 1" (2,5 cm) plastic LP 1 Y-filter stainless steel screen 150 mesh
- KP7001-FPR30-KIT** Drip control zone kit with 30 PSI pressure regulator and filter
- KP7001-FPR40-KIT** Drip control zone kit with 40 PSI pressure regulator and filter
- KPR8030** 1" (2,5 cm) pressure regulator, 30 PSI
- KPR8040** 1" (2,5 cm) pressure regulator, 40 PSI

dripline,  
bubblers





# Bubblers

Pressure compensating bubblers are ideal for non-turf areas.

[www.krain.com](http://www.krain.com)

## Features

- Pressure compensation ensures consistent flow rates over lower pressure ranges.
- Pressure compensating bubblers are ideal for tree and large shrub watering.

## Specifications

- Operating Pressure: 20 – 50 PSI (1,4 – 3,5 bar)
- Spacing: 1' – 3' (0,3 m – 0,9 m)
- Umbrella Pattern

## Fast Facts

All	Inlet: 1/2" (1,3 cm) female thread NPT
TB-025	Flow Rate: 0.25 GPM (0,06 M <sup>3</sup> /H; 0,95 L/M)
TB-05	Flow Rate: 0.5 GPM (0,114 M <sup>3</sup> /H; 1,9 L/M)
TB-10	Flow Rate: 1.0 GPM (0,227 M <sup>3</sup> /H; 3,8 L/M)
TB-20	Flow Rate: 2.0 GPM (0,454 M <sup>3</sup> /H; 7,6 L/M)
TB-ADJ	Flow Rate: 0.1 – 4.5 GPM (0,31 – 1,34 M <sup>3</sup> /H; 5 – 22 L/M)

## Models

- TB-025** 0.25 GPM (0,95 LPM) Bubbler
- TB-05** 0.5 GPM (1,9 LPM) Bubbler
- TB-10** 1.0 GPM (3,8 LPM) Bubbler
- TB-20** 2.0 GPM (7,6 LPM) Bubbler
- TB-ADJ** Adjustable Bubbler, Pressure Compensating



dripline,  
bubblers



# valves



## Valve Comparison Chart

Versatile and heavy-duty, ProSeries valves deliver long life and reliable performance. Offering a wide array of features and benefits, the K-Rain line is manufactured with the highest standards and provides exceptional functionality.

Item Number	PRO SERIES 100				PRO SERIES 150			PRO SERIES 200		
	7075	7075	7001	7001	7101	7115	7102	7201	7215	7202
<b>Models</b>	Female thread, SL, BSP	NFC, SL-NFC, BSP-NFC	Female thread, SL, BSP, MXB, MXM, BSP-MXM, BSP	BSP-NFC, MXM-NFC, BSP-MXM -NFC, MXB-NFC	Female thread, SL, BSP, J, J-SL, J-BSP, J-MXB	Female thread, BSP	Female thread, BSP	Female thread	Female thread	Female thread
<b>Specifications</b>										
Size	3/4"	3/4"	1"	1"	1"	1 1/2"	2"	1"	1 1/2"	2"
Flow range (GPM)	1-20	1-20	5-30	5-30	5-30	20-80	20-120	5-30	20-100	20-150
Pressure range (PSI)	20-150	20-150	20-150	20-150	10-150	20-150	20-150	6-200	6-200	6-200
<b>Features</b>										
Flow control	•		•		•	•	•	•	•	•
24VAC solenoid	•	•	•	•	•	•	•	•	•	•
Heavy duty, corrosion resistant	•	•	•	•	•	•	•	glass-filled nylon	glass-filled nylon	glass-filled nylon
Tilt diaphragm/piston assembly	•	•	•	•						
Manual external bleed screw	•	•	•	•	•	•	•			
Manual internal bleed through solenoid	•	•	•	•	•	•	•	•	•	•
Captured plunger	•	•	•	•	•	•	•	•	•	•
Self-cleaning metering screen	•	•	•	•						
Removable metering pin					•	•	•			
Angle/Globe Option						•	•			
Heavy duty Santoprene® diaphragm	•	•	•	•	•	•	•			
Glass-filled nylon construction and reinforced rubber diaphragm								•	•	•
Self-cleaning diaphragm	•	•	•	•	•	•	•	•	•	•
Water flow indicator	•	•	•	•	•	•	•	•	•	•
Electric or manual operation	•	•	•	•	•	•	•	•	•	•
Warranty	7 year	7 year	7 year	7 year	7 year	7 year	7 year	7 year	7 year	7 year
<b>Options</b>										
9VDC solenoid	•	•	•	•	•	•	•			
BSP inlet & outlet	•	•	•	•	•	•	•	•	•	•

electric valves

# ProSeries 100 Valves

A straight-through flow pattern reduces the risk of trapped debris.

## Features

- Heavy Duty, Corrosion and UV Resistant PVC Construction – Increases the life of the valve
- Tilt Diaphragm/Piston Assembly – Allows for a straight flow path of water, increasing the flow rate while reducing friction loss
- Debris Tolerant Design – Offers flexibility for use in potable or non-potable applications
- Manual External Bleed Screw – Provides for manual operation in system start up and easy valve maintenance
- Manual Internal Bleed Through Solenoid – Permits manual operation without discharging water outside valve
- Flow Control with Removable Handle – Delivers precise flow adjustment to the zone and allows you to remove the handle to prevent tampering (Except NFC)
- Captured Plunger – Remove the solenoid without losing the internal plunger
- Self Cleaning Screen – Screen is in flow path of water for self-cleaning action during operation

## Fast Facts

7075 (3/4") Models	Height: 4" (10,2 cm)
	Width: 3" (7,6 cm)
	Length: 4 1/2" (11,4 cm)
7001 (1") Models	Height: 4" (10,2 cm)
	Width: 3" (7,6 cm)
	Length: 5 1/4" (13,3 cm)

## Operating Specifications

U.S.			METRIC		
Pressure Loss in PSI			Pressure Loss in bar		
Flow GPM	3/4"	1"	Flow LPM	3/4"	1"
1	4.0		4	0,28	
5	5.0	2.2	19	0,34	0,15
10	6.0	3.0	38	0,41	0,21
15	11.0	3.5	57	0,76	0,24
20	14.0	4.0	76	0,97	0,28
30		5.0	114		0,34
Pressure Range			Pressure Range		
3/4"		1"	3/4"		1"
20-150 PSI			1,4-10,3 bar		

## Accessories

See page 55

## Electrical Specifications

- Solenoid: 24V AC 60 Hz
- Inrush Current: .43 Amps
- Holding Current: .25 Amps



## Models

<b>7075</b>	3/4" Female NPT Thread
<b>7075-NFC</b>	3/4" Female NPT Thread, No Flow Control
<b>7075-SL</b>	3/4" Female Slip
<b>7075-SL-NFC</b>	3/4" Female Slip, No Flow Control
<b>7075-BSP</b>	3/4" Female BSP Thread
<b>7075-BSP-NFC</b>	3/4" Female BSP Thread, No Flow Control
<b>7001</b>	1" Female NPT Thread x Female NPT Thread
<b>7001-SL</b>	1" Female Slip
<b>7001-BSP</b>	1" Female BSP Thread
<b>7001-NFC</b>	1" Female NPT Thread No Flow Control
<b>7001-SL-NFC</b>	1" Female Slip, No Flow Control

<b>7001-BSP-NFC</b>	1" Female BSP Thread, No Flow Control
<b>7001-MXB</b>	1" Male NPT Thread x 1" Male Barb
<b>7001-MXM</b>	1" Male NPT Thread x 1" Male Thread
<b>7001-BSP-MXM</b>	1" Male BSP Thread x 1" Male BSP Thread
<b>7001-MXM-NFC</b>	1" Male NPT Thread x 1" Male Thread, No Flow Control
<b>7001-BSP-MXM-NFC</b>	1" Male BSP Thread x 1" Male BSP Thread, No Flow Control
<b>7001-MXB-NFC</b>	1" Male NPT Thread x 1" Male Barb, No Flow Control

All valves equipped with 24VAC solenoids.

## How to Specify 9 Volt solenoid

MODEL	OPTION
7001	-9VDC

Example: 7001-SL-9VDC

electric valves

▪ **Flow Through**  
The unique tilted diaphragm creates a better flow path than traditional globe style electric valves by decreasing friction loss and increasing flow rate.



▪ **Manual Flow Control**  
Precisely adjust flow to the zone. Removable handle prevents tampering.



▪ **Self-Cleaning Screen**  
The straight flow path allows debris to move through and the water path flow cleans the diaphragm filter screen. This provides long life in applications using well or lake water.



▪ **Captured Plunger Solenoid**  
Easy removal when servicing without losing internal parts. Epoxy encapsulated solenoid design ensures longevity unlike the competition's overmolded solenoid.



▪ **Versatility**  
These 1" models can accept 1" PVC inside or 1 1/4" PVC fitting or bell end pipe outside  
- 7001  
- 7001-BSP  
- 7001-NFC  
- 7001-SL-NFC  
- 7001-BSP-NFC



Watch the video. Scan this code with your smartphone camera.

# ProSeries 150 Valves

Heavy Duty, Corrosion and UV Resistant PVC Construction.

## Features

- Manual External Bleed Screw – Provides for manual operation in system start up
- Manual Internal Bleed through Solenoid – Provides for manual operation without discharging water outside the valve
- Captured Plunger – Allows for the solenoid to be removed without losing the internal plunger
- Flow Control Option – For precise flow adjustment
- Removable Metering Pin – easily clean metering pin without disassembling

### 1-1/2" AND 2" MODELS

- Removable Inlet Cap – Allows for easy conversion from globe to angle-style valve
- Heavy Duty Diaphragm – Unique design improves durability of diaphragm

### JAR-TOP MODELS

- Threaded Jar-Top – Allows for quick removal of the cap for easy servicing after installation
- Glass-Filled Nylon Screw Cap – Increased durability

## Models

7101	1" Female NPT Thread
7101-SL	1" Female Slip
7101-BSP	1" Female BSP Thread
7101-BSP-FC	1" Female BSP Thread, with Flow Control
7101-FC	1" Female NPT Thread, with Flow Control
7101-SL-FC	1" Female Slip with Flow Control
7101-J	1" Female NPT Thread Jar-Top
7101-J-SL	1" Female Slip Jar-Top
7101-J-BSP	1" Female BSP Thread Jar-Top
7101-J-MXB	1" Male NPT Thread x 1" Barb Jar-Top
7101-ANGLE	1" Female NPT Thread
7101-ANGLE-FC	1" Female NPT Thread, with Flow Control
7101-ANGLE-SL	1" Female Slip
7101-ANGLE-SL-FC	1" Female Slip with Flow Control
7101-ANGLE-BSP	1" Female BSP Thread
7101-ANGLE-BSP-FC	1" Female BSP Thread, with Flow Control
7115	1 1/2" Female NPT Thread
7115-BSP	1 1/2" Female BSP Thread
7102	2" Female NPT Thread
7102-BSP	2" Female BSP Thread

## How to Specify 9 Volt solenoid

MODEL	OPTION
7101	-9VDC

Example: 7101-SL-9VDC

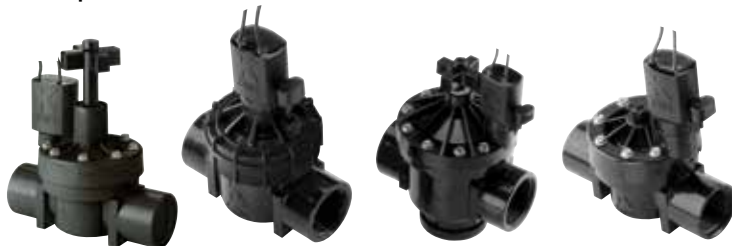

Accessories See page 55

## Fast Facts

7101 (1") Models	Height: 5 1/4" (13,3 cm) Width: 3 1/8" (7,95 cm) Length: Length: 5" (12,7 cm)
7101 (1") with Flow Control	Height: 5 7/8" (14,9 cm) Width: 3 1/8" (7,95 cm) Length: Length: 5" (12,7 cm)
7101 (1") Jar Top Models	Height: 5 1/4" (13,3 cm) Width: 3" (7,6 cm) Length: Length: 4 3/8" (11,1 cm)
7101-Angle (1") Models	Height: 5 1/2" (13,97 cm) Width: 3 1/8" (7,95 cm) Length: Length: 4" (10,6 cm)
7101-Angle-FC (1") with Flow Control	Height: 6 3/4" (17,1 cm) Width: 3 1/8" (7,95 cm) Length: Length: 4" (10,6 cm)
7115 (1.5") Models	Height: 8" (20,3 cm) Width: 4-1/4" (10,8 cm) Length: 5-1/2" (14 cm)
7102 (2") Models	Height: 8-7/8" (22,6 cm) Width: 4-7/8" (12,4 cm) Length: 6-1/3" (16,1 cm)

## Manual External Bleed Screw

The 1", 1 1/2" and 2" models feature a removable external bleed screw and metering pin to simplify cleaning and maintenance. With the External Bleed Screw, manual operation during start up is easy.

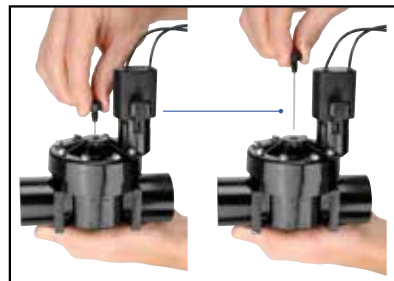

## Electrical Specifications

- Standard Solenoid: 24V AC 60 Hz
- Inrush Current: .43 Amps
- Holding Current: .25 Amps

## System Flexibility

Removable inlet cap allows for easy conversion from globe to angle-style valve.



## Operating Specifications

ProSeries 150 Pressure Loss in PSI - U.S.									
Flow GPM	1" Globe	1" Globe with Flow Control	1" Jar Top	1" Angle	1" Angle with Flow Control	1 1/2" Globe	1 1/2" Angle	2" Globe	2" Angle
5	2.9	6.0	3.3	2.5	2.2				
10	2.1	4.1	3.9	2.7	2.8				
15	1.8	4.1	2.9	4.6	3.7				
20	3.0	3.1	3.2	6.7	4.1	3.0	2.7	2.2	1.9
30	5.0	6.0	6.1	9.3	8.6	2.6	2.2	1.9	1.9
40						2.3	1.9	1.7	1.7
50						2.9	2.2	1.5	1.5
60						4.1	3.0	1.6	1.5
80						5.5	4.4	2.9	2.1
100								4.8	3.2
120								6.2	4.6

Pressure Range									
1" Globe	1" Globe with Flow Control	1" Jar Top	1" Angle	1" Angle with Flow Control	1 1/2" Globe	1 1/2" Angle	2" Globe	2" Angle	
10-150 PSI					20-150 PSI				

ProSeries 150 Pressure Loss in bar - METRIC									
Flow LMP	1" Globe	1" Globe with Flow Control	1" Jar Top	1" Angle	1" Angle with Flow Control	1 1/2" Globe	1 1/2" Angle	2" Globe	2" Angle
18	0,20	0,41	0,23	0,17	0,15				
38	0,14	0,28	0,27	0,19	0,19				
57	0,12	0,28	0,20	0,32	0,26				
76	0,21	0,21	0,22	0,46	0,28	0,21	0,19	0,15	0,13
114	0,34	0,41	0,42	0,64	0,59	0,18	0,15	0,13	0,13
151						0,16	0,13	0,12	0,12
189						0,20	0,15	0,10	0,10
227						0,28	0,21	0,11	0,10
303						0,38	0,30	0,20	0,14
379								0,33	0,22
454								0,43	0,32

Pressure Range									
1" Globe	1" Globe with Flow Control	1" Jar Top	1" Angle	1" Angle with Flow Control	1 1/2" Globe	1 1/2" Angle	2" Globe	2" Angle	
0,7-10,3 bar					1,4-10,3 bar				

electric valves

# ProSeries 200 Valves

A durable, feature-packed electric valve designed to handle up to 200 PSI.

## Features

- Durable Glass-filled Nylon Construction and Reinforced Rubber Diaphragm – Ensures long life and reliable performance
- Flow Control – Adjust water flow as needed
- Large Internal Openings and Self-cleaning Diaphragm During Every Cycle – Reduces maintenance time
- Water Flow Indicator – Ensures proper installation every time
- Electric or Manual Operation

## Models

- 7201** 1" Female NPT Thread  
**7215** 1 1/2" Female NPT Thread  
**7202** 2" Female NPT Thread

## How to Specify BSP

MODEL	OPTION
7201	-BSP

**Example:** 7201-BSP

## Electrical Specifications

- Standard solenoid: 24V AC 60 Hz
- Inrush current: .43 amp
- Holding current: .25 amp

## Fast Facts

7201 (1") Models	Height: 5-1/4" (13,3 cm) Width: 3-1/8" (7,9 cm) Length: 5-1/8" (13,0 cm)
7201 (1") Jar Top Models	Height: 5-3/4" (14,6 cm) Width: 3-1/8" (8 cm) Length: Length: 4-3/4" (12,0 cm)
7215 (1.5") Models	Height: 6-3/4" (17,2 cm) Width: 4-1/4" (10,8 cm) Length: 6-1/4" (15,9 cm)
7202 (2") Models	Height: 7" (17,8 cm) Width: 4-1/4" (10,8 cm) Length: 7-1/4" (18,4 cm)

## Operating Specifications

ProSeries 200 Pressure Loss in PSI - U.S.			
Flow GPM	1" Globe	1 1/2" Globe	2" Globe
5	0.4		
10	1.2		
15	2.5		
20	4.7	2.7	2.9
25	7.3	3.0	2.5
30	9.7	2.9	2.2
40		2.9	2.2
50		3.4	2.8
60		4.2	3.4
80		7.6	5.5
100		12.9	7.8
120			11.7
150			20.0

Pressure Range		
1" Globe	1 1/2" Globe	2" Globe
6 - 200 PSI		

ProSeries 200 Pressure Loss in bar - METRIC			
Flow GPM	1" Globe	1 1/2" Globe	2" Globe
19	0,03		
38	0,08		
57	0,17		
76	0,32	0,19	0,20
95	0,50	0,21	0,18
114	0,67	0,20	0,15
151		0,20	0,15
189		0,24	0,19
227		0,29	0,23
303		0,52	0,38
379		0,89	0,54
454			0,80
568			1,38

Pressure Range		
1" Globe	1 1/2" Globe	2" Globe
0,4-13,8 bar		



**Accessories** See page 55



## Models

### SOLENOIDS AND ADAPTERS

- P3008113** 24V AC Solenoid
- P3008114** 9V DC Latching Solenoid
- P3004750** Replacement K-Rain® Kit: 24V solenoid with Rain Bird® & Hunter® adapters (1 each)
- P3004758** Replacement K-Rain® Kit: 9V solenoid with Rain Bird® & Hunter® adapters (1 each)
- P3004760** Rain Bird® & Hunter® adapter for K-Rain® 24V or 9V solenoid (1 each)
- P3004770** K-Rain 24V or 9V solenoid adapters for Rain Bird® (5 pack)
- P3004780** K-Rain 24V or 9V solenoid adapters for Hunter® (5 pack)
- P3004810** 24V Solenoid, 1 Signature Adapter
- P3004815** 9V Solenoid, 1 Signature Adapter
- P3004820** 5 pack Signature Adapters



### VALVE BOXES

- VB60** K-Rain Round Valve Box 6" (Box Black, Lid Green)
- VB101** K-Rain Round Valve Box 10" (Box Green, Lid Green)
- VB121** K-Rain Valve Box 12"x 17"x 12" (Box Green, Lid Green)
- VB121-X** K-Rain Valve Extension 12"x 17"x 6" (Box Green, Lid Green)
- VB151** K-Rain Valve Box 15"x 21"x 12" (Box Green, Lid Green)
- VB151-X** K-Rain Valve Extension 15"x 21"x 6" (Box Green, Lid Green)



electric valves

# controllers



## Controller Comparison Chart

K-Rain controllers offer a full range of water management products to meet the needs of any irrigation project. From the simplest timer to WiFi, Bluetooth or the most advanced 2-wire decoder controller, K-Rain controllers are recognized as feature-packed yet easy to program.

	SiteMaster	Pro EX 2.0	Pro-LC WiFi	K-Rain BLUE®	RPS46
Controller Type	2-Wire Decoder	Modular WiFi Ready	Conventional WiFi Ready	Bluetooth Battery	Mini
<b>Specifications</b>					
Stations/zones	1 to 99	Up to 28	4, 8, 12	1, 2, 4	4, 6
Programs	6	3	3	6	4
Start times per program	6	4	4	8	4
<b>Features</b>					
Hand-held remote control compatible		•		smart device	
App controlled		with WiFi option	with WiFi option	•	
WiFi capability		optional	optional		
Full program display	•	•	•	In app	
Backlit display	•	•			
Seasonal adjust	•	•	•	•	•
Buried valve locator		•	•		
Flow sensor ready	•	•			
Rain/freeze sensor ready	•	•	•	•	•
Weather station ready	•	with WiFi option	with WiFi option		
Permanent memory	•	•	•	•	
Max number of stations running simultaneous	12	1	1	1	1
Station delay	•	•	•		
Pump/MV programmable	Up to 5	•	•	2, 4 stations	•
Geo-locate function				•	
Battery Backup	•	•	•	•	•
Battery Backup Time/Date					9VDC
Warranty	3 year	3 year	3 year	3 year	3 year

# SiteMaster

## 2-Wire Decoder Controller

### Features

- Number of stations: Up to 99
- Weather station capable
- Connect up to 2 hard-wired flow meters and 3 additional meters attached to decoders in the field
- Upgradeable to internet mode by simply adding the 3404 Network Module to be the interface between your router (cellular or WiFi) and the SiteMaster controller.
- Rain sensor and rain/freeze sensor ready
- 6 independent programs with 6 start times each
- Full on-screen keyboard makes naming and programming easy and intuitive
- Advanced diagnostics include interactive fault log, decoder signal strength/status
- Largest screen in the industry displays run times, watering days, number of start times
- Two fully independent wire paths for easy layout design and trouble shooting
- Special features include seasonal adjust, station/zone grouping, program backup and restore
- Station delay/overlap and pump pressurization allows dual operation and pressurization for each of 5 separate pump start locations
- Vandal-resistant lockable housing

### Fast Facts

3400	Height: 11.91" (30,3 cm) Width: 15 1/2" (39,2 cm) Depth: 6 1/2" (16,33 cm)
3420	Height: 16" (41,0 cm) Width: 18 1/2" (47,0 cm) Depth: 9 1/4" (23,5 cm)
3421	Height: 38" (96,5 cm) Width: 16 1/2" (41,9 cm) Depth: 17 1/4" (43,8 cm)



## Specifications

### OPERATING SPECIFICATIONS

- Station Run Times: 1 second to 9:59:59 Programs A, B, C, D, E, & F
- Start Times: 6 per program
- Watering Schedule: 7 Day Calendar (any day of the week), odd/even days, interval watering up to 31 days
- Operating Temperature: 0°–140° F (18°–60° C)
- Zone Capacity: 99 zone groups limited to 6 zones and 1 MV/PS per primary line. Add up to 12 zones (A and B total).
- Pump Start Requirements: Pump Starts wired directly to the controller require a K-Rain 1520 or 1510 mini coil power relay. Remote pump start relays on the 2-wire path require a K-Rain 3410 Optical Pump Start Relay in conjunction with a K-Rain 1520 or 1510 mini coil power relay.

### ELECTRICAL SPECIFICATIONS

- 2-Wire transformer; Input: 120/240 50/60 Hz  
Max Output: 27 VAC 100VA 3.7 AMP
- Midbox Transformer; Input: 120/240 50/60 Hz  
Max Output: 24 VAC 40VA 1.71 AMP
- Battery: 2032 Coin Cell (included)  
9V alkaline battery (optional, not included)

## Models

- 3400** 110 VAC 2-wire decoder controller
- 3400-220** 220 VAC 2-wire decoder controller
- 3420** 110 VAC 2-wire decoder controller in stainless steel cabinet
- 3420-220** 220 VAC 2-wire decoder controller in stainless steel cabinet
- 3421** 110 VAC 2-wire decoder controller on stainless steel pedestal
- 3421-220** 220 VAC 2-wire decoder controller on stainless steel pedestal

\*Above models include 3403 2-wire module.

## Accessories

See page 67



Watch the video. Scan this code with your smartphone camera.

# PRO EX 2.0 Modular Irrigation Controllers

Available as a WiFi kit or WiFi enabled units.

## Features

- WiFi enabled – Syncs with WiFi to allow functionality through a smartphone, tablet or web browser. Weather IQ with adjustable limits. Remote access and alerts
- Expandable up to 28 stations. Add hot-swappable 4 and 14 station expansion modules and run 4, 8, 12, 14, 16, 18, 22 or 28 stations
- Patented Full Program Display – One screen shows watering days, number of start times, number of stations and special programming
- Flow Sensor Ready – Connects directly. Has high/low flow abort settings and provides flow data capture up to 7 days on device and full history on web browser when configured as a WiFi controller
- Rain sensor and rain/freeze sensor ready – Allows automated operation to be controlled by sensor
- RF Module Connector – Allows for optional installation of wireless accessories: Handheld remote, wireless rain sensor and WiFi hub
- Diagnostic Circuit Breaker – Identifies and isolates stations with valve or wiring problems (shorts, faults, valve location) while remaining program continues
- Advanced Diagnostics – Visual and/or audible alerts when programming errors or other conditions have been detected and are preventing operation
- Station Delay/Overlap Programming – Additional time between stations or dual operation for issues like well recovery, slow closing valves and water hammer
- Large Backlit LCD Screen – Best in class visualization for all installations
- AM/PM or 24 Hour Clock Settings – Allows user to choose the time format desired
- Manual Start – Manual program operation at the push of a button
- Permanent Memory – Non-volatile memory saves program during power outages

## Fast Facts

- Height: 7 3/4" (19,6 cm)
- Width: 10" (25,4 cm)
- Depth: 5" (12,7 cm)



- Buried Valve Locate Feature – Helps locate buried valves in field
- Sensor Bypass Switch – Global override of active sensor for all stations
- Master Valve/Pump Start Ready – Programming for individual station(s) operation as needed
- Valve Test Terminal (VT) – Quick and easy matching of field wires with station during installation
- Default Programming – Allows program to be saved and recalled without having to reprogram
- Permanent Day Off – Set any day of the week, regardless of programming, as a non-watering day
- Seasonal Adjust – Quick, easy global adjustment of watering times from 10-200% conserves water
- Built-in Level – Makes leveling the unit easy during install

## Specifications

### OPERATING SPECIFICATIONS

- Station Run Times: 1 second to 6 hours for all stations
- Number of Programs: 3
- Number of Automatic Start Times: 4 per program
- Program Watering Schedules: Custom (day of the week), Interval (1-31 days), Odd (odd calendar days), Even (even calendar days)

### ELECTRICAL SPECIFICATIONS

- Power Input: 110V AC, 50/60Hz, 240V AC, 50/60Hz
- Power Output: 24V AC 1.25Amp
- Power Backup: Lithium coin-cell battery maintains time and date during primary power outages while the 4 AAA batteries allow for remote programming and LCD viewing



WiFi kit shown

# PRO EX 2.0 Modular Irrigation Controllers

Available as a WiFi kit or WiFi enabled units.

## Models

### INDOOR MODELS

**3202ID** PRO EX 2.0 4 station indoor modular controller, 110V AC plug pack transformer

**3202ID-220** PRO EX 2.0 4 station indoor modular controller, 220V AC plug pack transformer

**3202ID-WIFI-KIT** PRO EX 2.0 WiFi enabled 4 station indoor modular controller, WiFi hub, RF module, short range antenna, 110V AC plug pack transformer. Free iOS/android apps.

**3202ID-220-WIFI-KIT** PRO EX 2.0 WiFi enabled 4 station indoor modular controller, WiFi hub, RF module, short range antenna, 220V AC plug pack transformer. Free iOS/android apps

### OUTDOOR MODELS

**3202** PRO EX 2.0 4 station outdoor modular controller, 110 AC internal transformer

**3202-P** PRO EX 2.0 4 station indoor modular controller, with pigtail, 110V AC internal transformer

**3202-220** PRO EX 2.0, 4 station outdoor modular controller, 220 VAC internal transformer

**3202-WIFI-KIT** PRO EX 2.0 WiFi enabled 4 station outdoor modular controller, WiFi hub, RF module, short range antenna. Free iOS/android apps.

**3202-P-WIFI-KIT** PRO EX 2.0 WiFi enabled 4 station outdoor modular controller, WiFi hub, RF module, short range antenna, with pigtail. Free iOS/android app.

**3202-220-WIFI-KIT** PRO EX 2.0 WiFi enabled 4 station outdoor modular controller, WiFi hub, RF module, short range antenna, 220V AC plug pack transformer. Free iOS/android app.



## Accessories

See page 67



Feature-packed, user friendly and a WiFi-Capable controller.

## Features

- Easy to follow programming
- Large LCD display
- Patented full program display feature shows days, start times, number of stations and special programming
- WiFi requires the BRIDGE WiFi Module, sold separately
- Rain sensor and rain/freeze sensor ready
- Seasonal adjust
- Buried valve locator
- Built-in Level – Makes leveling the unit easy.

## Specifications

### OPERATING SPECIFICATIONS

- Station Run Times: 1 minute to 6 hours
- Number of Programs: 3
- Number of Automatic Start Times: 4 per program
- Program Watering Schedules:
  - Odd (odd calendar days),
  - Even (even calendar days),
  - Custom (day of the week)
  - Interval 1-31 days

### ELECTRICAL SPECIFICATIONS

- Power Input:
  - 110V AC, 50/60Hz
  - 240V AC, 50/60Hz
- Power Output: 24V AC 1.0Amp
- Power Backup: Lithium coin-cell battery maintains time and date during primary power outages.

## Accessories

See page 66



Bridge WiFi Module

## Fast Facts

All	Height: 7" (17,8 cm)
	Width: 7" (17,8 cm)
	Depth: 3 1/2" (8,9 cm)

## Models

### OUTDOOR MODELS

<b>3104W</b>	4 station, 110V AC internal transformer
<b>3104W-P</b>	4 station, 110V AC internal transformer w/pigtail
<b>3104W-220</b>	4 station, 220V AC internal transformer
<b>3108W</b>	8 station, 110V AC internal transformer
<b>3108W-P</b>	8 station, 110V AC internal transformer w/pigtail
<b>3108W-220</b>	8 station, 220V AC internal transformer
<b>3112W</b>	12 station, 110V AC internal transformer
<b>3112W-P</b>	12 station, 110V AC internal transformer w/pigtail
<b>3112W-220</b>	12 station, 220V AC internal transformer

### INDOOR MODELS

<b>3104WID</b>	4 station, 110V AC plug pack transformer
<b>3104WID-220</b>	4 station, 220V AC plug pack transformer
<b>3108WID</b>	8 station, 110V AC plug pack transformer
<b>3108WID-220</b>	8 station, 220V AC plug pack transformer
<b>3112WID</b>	12 station, 110V AC plug pack transformer
<b>3112WID-220</b>	12 station, 220V AC plug pack transformer
<b>3100-BRIDGE</b>	BRIDGE WiFi Module



irrigation controllers



Basic manual programming



Advanced manual programming



Wi-Fi Irrigation Controller setup for homeowners



Wi-Fi Irrigation controller setup for contractors

Watch the video. Scan the code with your smartphone camera.

# RPS™ 46

The easiest to use mini irrigation controller.

## Features

- 4 & 6 Station Models – Perfect for residential lawn
- 4 Fully Independent Programs – Allowing up to 4 starts per program. Maximum 16 starts per day
- Seasonal Adjustment – Allows for quick adjustment of watering durations in 10% increments from 10% to 200%
- Rain sensor and rain/freeze sensor ready – Allows automated operation to be controlled by sensor
- Flexible Manual Operation – Run a program, run a station or test system
- Battery Back-Up – Saves program during power outages
- Indoor Models with External Transformer & Plug

## Specifications

### OPERATING SPECIFICATIONS

- Station Run Times: 1 min. to 12 hrs. 59 min.
- Number of Programs: 4
- Number of Automatic Start Times: 4 per program
- Program Watering Schedules: 7 day calendar with individual day selection, or 1 to 15 day interval, or 365 day calendar for ODD/EVEN day watering
- Master Valve/pump start terminal
- Automatic, semi-automatic and single station manual operation

### ELECTRICAL SPECIFICATIONS

- Power Input: 110V AC, 50/60Hz, 240V AC, 50/60Hz
- Power Output: 24V AC, 1.0 AMP
- To Solenoid Valve: 24V AC, 0.5 AMPS max
- Overload protection: Standard 20mm 1.0 AMP fuse
- Power Failure: 9 Volt standard alkaline battery maintains clock and program up to 2 week.
- Wiring: The output circuits should be installed and protected in accordance with wiring rules

## Fast Facts

All	Height: 5 3/4" (14,5 cm)
	Width: 4 1/2" (11,43 cm)
	Depth: 1 3/4" (4,3 cm)



## Models

<b>3504</b>	4 Station, 110V Plug Pack Transformer
<b>3504-220</b>	4 Station, 220V Plug Pack Transformer (International only)
<b>3506</b>	6 Station, 110V Plug Pack Transformer (International only)
<b>3506-220</b>	6 Station, 220V Plug Pack Transformer

## Accessories

See page 66, Rain Sensor

Bluetooth battery powered controller.

[www.krain.com](http://www.krain.com)

## Features

- Ideal for areas where AC power is unavailable
- Change controller settings via smartphone, tablet or web browser
- Manage hundreds of controllers from one easy app
- Geo-location feature – see every site, every controller, every program
- CrewView™ feature allows program visibility anywhere
- Alerts you when a battery replacement is required
- Rain sensor and rain/freeze sensor ready – Allows automated operation to be controlled by sensor
- IP68 certified fully waterproof enclosure installs right in the valve box
- 1, 2 and 4 station models.
- Molded out of UV resistant, high impact ABS resin
- Ideal for isolated/remote valve boxes where running power is expensive or difficult
- Standalone – works with 9V DC alkaline battery type.
- Full virtual back up – back up program information & preferences to the cloud for easy future restoration
- Seasonal adjust
- Manually start, stop or suspend your controller(s) from up to 35' away
- Add a passcode lock to each controller for added security

## Fast Facts

All	Height: 2 1/8" (5,5 cm)
	Width: 5 1/2" (14 cm)
	Depth: 3 1/2" (9 cm)

## Specifications

### OPERATING SPECIFICATIONS

- 1, 2 and 4 stations
- Master valve connection (Except for BLUE-1 single station)
- 6 programs, 8 start times
- Bluetooth range; 35' (10 m)

### ELECTRICAL SPECIFICATIONS

- Works with 9V DC latching solenoids and a master valve equipped with a 9V DC latching solenoid
- Maximum distance between the timer and solenoid is 98' (30 m) with 18 AWG (.05" or 1,55 mm<sup>2</sup>)

## Models

<b>BLUE-1</b>	1 Station
<b>BLUE-2</b>	2 Station
<b>BLUE-4</b>	4 Station

irrigation  
controllers



# Rain Sensor

Turn your irrigation controller into an expert water manager.

## Features

### UNIVERSAL RAIN SENSOR RECEIVER

- Flexibility. Allows a K-Rain Wireless Rain/Freeze Sensor to be paired with any manufacturer's rain sensor terminal equipped controller
- Simplicity. Provides the advantage of extremely quick, easy installation and programming, along with simple pairing with a K-Rain Rain Sensor
- Weather Resistant. Engineered with impact modified, UV resistant polymer for outdoor exposure
- Maintenance Free. No batteries to replace

### RAIN/FREEZE SENSORS

- K-Rain Rain Sensor products efficiently suspend watering during rain and/or freeze periods.
- The K-Rain wireless rain-freeze sensor can be paired with multiple K-Rain PRO EX 2.0 WiFi enabled controllers within range, providing an additional value for the end user. The wired rain sensors work with closed circuit timers.
- 2 in 1 Mounting. Provides flexible installation with standard flat & gutter mounting
- Models 3208-WRFS and 3208-HRFS include a freeze sensor that prevents the irrigation system from starting when temperatures drop to 37°F or below

## Models

<b>3208-HRS</b>	Hardwired Rain Sensor
<b>3208-HRFS</b>	Hardwired Rain-Freeze Sensor
<b>3208-WRFS</b>	Wireless Rain/Freeze Sensor for PRO EX 2.0 or PRO EX 2.0 WiFi
<b>3208-WRFS-KIT</b>	Wireless Rain/Freeze Sensor and RF Module for PRO EX 2.0
<b>3208-UWRFS</b>	Universal Wireless Rain/Freeze Sensor



# Controller Accessories



www.krain.com

		SiteMaster	PRO EX 2.0	PRO-LC	RPS 46	K-Rain BLUE®
<b>Accessories</b>						
3100 BRIDGE	Bridge WiFi Module			•		
3202-WIFI BUNDLE-KIT	WiFi hub, RF module with small antenna, large antenna with coax cable		•			
3202-220-WIFI-BUNDLE-KIT	WiFi hub, RF module with small antenna, large antenna with coax cable		•			
3203	Handheld Remote with batteries		•			
3203-KIT	Handheld Remote with batteries, RF Module with short distance antenna, long range antenna and coaxial cable		•			
3205	4 Station Expansion Module		•			
3205-14	14 Station Expansion Module		•			
3206	RF module with short distance antenna		•			
3208-HRS	Hardwired Rain Sensor	•	•	•	•	•
3208-HRFS	Hardwired Rain/Freeze Sensor	•	•	•	•	•
3208-WRFS	Wireless Rain/Freeze Sensor and RF Module	•	•			
3208-WRFS KIT	Wireless Rain/Freeze Sensor and RF Module	•	•			
3208-UWRFS	Universal Wireless Rain/Freeze Sensor	•	•	•	•	
3209	WiFi Hub		•			
3401	Single Station Decoder	•				
3402	Surge Protector	•				
3403	2-Wire Module	•				
3404	Network Module	•				
3410	Optical Pump Start Relay	•				
3414	Pro Weather Station	•				
FS228-15	1.5" Flow Sensor Assembly	•	•			
FS228-20	2" Flow Sensor Assembly	•	•			
FS228-30	3" Flow Sensor Assembly	•	•			
FS228-40	4" Flow Sensor Assembly	•	•			
FS735-10	1" Flow Sensor Assembly	•	•			

3203



3205



3208-UWRFS



irrigation controllers



# Pump Start Relays

The rain-tight, secure, rustproof enclosure provides a safe, secure housing built to last.

## Features

- The Pump Start Relay enclosure is constructed with a corrosion resistant, UV resistant, shockproof material

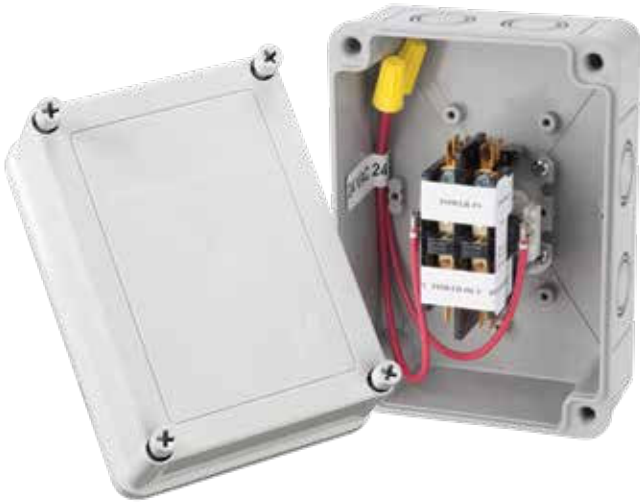

pump start relays

## Models

- |   |  |
|---|--|
| <p><b>1510</b> Coil Specifications<br/>120V AC, 60 Hz<br/>Inrush: 35 VA<br/>Sealed: 7.0 VA<br/>Resistance (<math>\pm 10\%</math>):<br/>250 OHMS<br/>Mini Coil<br/>24V AC, 50/60 Hz<br/>Inrush: 52 mA</p>  | <p>Double Pole, Single Throw<br/>Inductive: 20 AMP<br/>Resistive: 30 AMP<br/>Input: 120V AC - up to 2 H.P.<br/>UL Rated</p> <p>Sealed: 1.2 VA<br/>Resistance (<math>\pm 10\%</math>): 155 OHMS</p> |
| <p><b>1520</b> Coil Specifications<br/>240V AC, 60 Hz<br/>Inrush: 35 VA<br/>Sealed: 7.0 VA<br/>Resistance (<math>\pm 10\%</math>):<br/>1000 OHMS<br/>Mini Coil<br/>24V AC, 50/60 Hz<br/>Inrush: 52 mA</p> | <p>Double Pole, Single Throw<br/>Inductive: 20 AMP<br/>Resistive: 30 AMP<br/>Input: 240V AC - up to 3 H.P.<br/>UL Rated</p> <p>Sealed: 1.2 VA<br/>Resistance (<math>\pm 10\%</math>): 155 OHMS</p> |
| <p><b>1521</b> Coil Specifications<br/>120V AC, 60 Hz<br/>Inrush: 42 VA<br/>Sealed: 8.5 VA, 3.6 Watts<br/>Resistance (<math>\pm 10\%</math>):<br/>210 OHMS</p>  | <p>Double Pole, Single Throw<br/>Inductive: 20 AMP<br/>Resistive: 30 AMP<br/>Input: 120V AC - up to 3 H.P.<br/>240V AC - up to 3 H.P.</p>  |
| <p><b>1522</b> Coil Specifications<br/>24V AC, 60 Hz<br/>Inrush: 35 VA<br/>Sealed: 7 VA, 3 Watts<br/>Resistance (<math>\pm 10\%</math>):<br/>11 OHMS</p>  | <p>Double Pole, Single Throw<br/>Inductive: 20 AMP<br/>Resistive: 30 AMP<br/>Input: 120V AC - up to 3 H.P.<br/>240V AC - up to 3 H.P.</p>  |
| <p><b>1551</b> Coil Specifications<br/>120V AC, 60 Hz<br/>Inrush: 77 VA<br/>Sealed: 10 VA, 4 Watts<br/>Resistance (<math>\pm 10\%</math>):<br/>89.5 OHMS</p>  | <p>Double Pole, Single Throw<br/>Inductive: 40 AMP<br/>Resistive: 50 AMP<br/>Input: 120V AC - up to 3 H.P.<br/>240V AC - up to 5 H.P.</p>  |
| <p><b>1552</b> Coil Specifications<br/>24V AC, 60 Hz<br/>Inrush: 60 VA<br/>Sealed: 7 VA, 2.3 Watts<br/>Resistance (<math>\pm 10\%</math>):<br/>5.61 OHMS</p>  | <p>Double Pole, Single Throw<br/>Inductive: 40 AMP<br/>Resistive: 50 AMP<br/>Input: 120V AC - up to 3 H.P.<br/>240V AC - up to 5 H.P.</p>  |
| <p><b>1553</b> Coil Specifications<br/>24V AC, 60 Hz<br/>Inrush: 60 VA<br/>Sealed: 7 VA, 2.7 Watts<br/>Resistance (<math>\pm 10\%</math>):<br/>5.61 OHMS</p>  | <p><b>THREE PHASE OPERATION</b><br/>Triple Pole, Single Throw<br/>Inductive: 40 AMP<br/>Resistive: 50 AMP<br/>Input: 120V AC - up to 3 H.P.<br/>240V AC - up to 10 H.P.</p>                        |

# Single Station Controller

Time-tested reliability and safe, rain-tight enclosures.

[www.krain.com](http://www.krain.com)

## Features

### 2100 MODELS

- 24 hour programmable time dial
- Multiple start times
- Wide variety of timing periods
- "Skip-A-Day" 14 day program

### 2200 MODELS

- Perfect for nursery and other mist applications
- 10 minute programmable dial
- Wide variety of timing periods
- Multiple start times

### 2500 MODELS

- Prewired for easy connection of a rainswitch, allowing for manual override of rainswitch from controller face



## Models

### 2100 SINGLE STATION CONTROLLERS

<b>2110</b>	Voltage Input: 110V AC, 60 Hz Output: 110V AC, 60 Hz	Rating Single Pole, Single Throw Relay Rated for up to 1 H.P.
<b>2112</b>	Voltage Input: 110V AC, 60 Hz Output: 110V AC, 60 Hz	Rating Double Pole, Single Throw Relay Rated for up to 2 H.P.
<b>2114</b>	Voltage Input: 110V AC, 60 Hz Output: 24V AC, 30 VA	Rating Built-In Transformer
<b>2120</b>	Voltage Input: 220V AC, 60 Hz Output: 220V AC, 60 Hz	Rating Double Pole, Single Throw Relay Rated for up to 2 H.P.
<b>2124</b>	Voltage Input: 220V AC, 60 Hz Output: 24V AC, 20 VA	Rating Built-In Transformer

### 2200 SHORT DURATION SINGLE STATION CONTROLLERS

<b>2210</b>	Voltage Input: 110V AC, 60 Hz Output: 110V AC, 60 Hz	Rating Relay Rated for up to 1 H.P.
<b>2214</b>	Voltage Input: 110V AC, 60 Hz Output: 24V AC, 30 VA	Rating Built-In Transformer

### 2500 RAINSWITCH-READY CONTROLLERS

<b>2510</b>	Voltage Input: 110V AC, 60 Hz Output: 110V AC, 60 Hz	Rating Double Pole, Single Throw Relay Rated for up to 2 H.P.
<b>2514</b>	Voltage Input: 110V AC, 60 Hz Output: 24V AC, 30 VA	Rating Built-In Transformer
<b>2520</b>	Voltage Input: 220V AC, 60 Hz Output: 220V AC, 60 Hz	Rating Double Pole, Single Throw Relay Rated for up to 2 H.P.

single station  
controller

# 4000 Series Indexing Valve

A reliable, economical way to automate multiple zoned residential and small commercial irrigation systems.

## Features

- ABS Polymer Construction – High-strength, non-corrosive body for long product life
- Available in 4 and 6 Outlet Models – Can quickly and easily change from two to six watering zones
- Simplicity of Design – Valves are easily maintained and serviced for long product life
- Operates at a low 10 GPM (38 LPM) flow rate at Pressures of 25-75 PSI (1,7-5,2 bar) – Reliably automates multiple zoned residential and small commercial irrigation or wastewater systems

## Models

### FOUR OUTLET MODELS

- 4400** No Cam
- 4402** Cammed for 2 Zone Operation
- 4403** Cammed for 3 Zone Operation
- 4404** Cammed for 4 Zone Operation

### SIX OUTLET MODELS

- 4600** No Cam
- 4602** Cammed for 2 Zone Operation
- 4603** Cammed for 3 Zone Operation
- 4604** Cammed for 4 Zone Operation
- 4605** Cammed for 5 Zone Operation
- 4606** Cammed for 6 Zone Operation

Other options add to part number:

- RCW** Reclaimed Water Use

\*4000 Series Valves are available with 1" inlet and outlet by custom order

## Accessories\*

- P7005507** Stem/disk Assembly Standard (.029-White) 10 GPM\*\* (38 LPM)
- P7005509** Stem/disk Assembly Light (.025-Blue) 6 GPM (23 LPM)
- P7005511** Stem/disk Assembly Heavy (.032-Red) 15 GPM (57 LPM)

\*Color code identified at the bottom of the disk

\*\*Pre-installed

## Fast Facts

All	Non-Corrosive ABS Polymer
	Height: 5 3/4" (14,6 cm) Width: 5 3/4" (14,6 cm)
4 Outlet Models	1 1/4" x 1 1/4" (3,2 cm x 3,2 cm)
6 Outlet Models	1 1/4" x 1" (3,2 cm x 2,5 cm)

## Operating Specifications

4 OUTLET VALVE				
Flow Rate, GPM	10	20	30	40
PSI Loss	2.0	3.0	4.5	6.4
Pressure Range:	25-75 PSI (0,7-3,4 bar)			
Flow Range:	10-40 GPM (37,9-151,4 LPM)			

6 OUTLET VALVE			
Flow Rate, GPM	10	20	30
PSI Loss	2.5	4.5	7.5
Pressure Range:	25-75 PSI (0,7-3,4 bar)		
Flow Range:	10-30 GPM (37,9-113,6 LPM)		





# 6000 Series Indexing Valve

The 6000 line of indexing valves offers exceptional reliability and durability even under the dirtiest water conditions.

## Features

- Metal Die-Cast Body – Durable, long lasting and capable of high pressure applications
- Available in 4 and 6 Outlet Models – Can quickly and easily change number of watering zones with a cam change
- Simplicity of Design – Valves are easily maintained & serviced for long product life
- Operates at 15 GPM at Pressures of 25–150 PSI – Ideal for pump-fed systems or high-flow city water systems
- Built-in Atmospheric Vacuum Breaker – Releases any vacuum created between the pump and the valve on shut down

## Models

### FOUR OUTLET MODELS

- 6402** Cammed for 2 Zone Operation
- 6403** Cammed for 3 Zone Operation
- 6404** Cammed for 4 Zone Operation

### SIX OUTLET MODELS

- 6605** Cammed for 5 Zone Operation
- 6606** Cammed for 6 Zone Operation

Other options add to part number:

- RCW** Reclaimed Water Use

## Accessories\*

- P8003050** Stem/disk Assembly Standard Heavy (.032-Red) 15 GPM\*\* (57 LPM)
- P8003051** Stem/disk Assembly Light (.028-White) 10 GPM (38 LPM)
- P8003052** Stem/disk Assembly Extra Light (.025-Blue) 6 GPM (23 LPM)

\*Color code identified at the bottom of the disk

\*\*Pre-installed

## Fast Facts

Valve Top/Housing:	Die Cast Metal
Valve Outlets:	High Strength ABS Polymer
Inlet:	Threaded 1 1/2" (3,8 cm) NPT Connection
Outlets:	Slip & Glue Connections to 1 1/2" (3,8 cm) PVC Pipe
Height:	7" (17,8)
Width:	8" (20,3)

## Operating Specifications

4 OUTLET VALVE					
Flow Rate, GPM	20	40	60	80	100
PSI Loss	2.5	3.5	5.0	7.5	10.0
Pressure Range: 25 - 150 PSI (1,7 to 10,3 bar)					
Flow Range: 15-150 GPM (57-568 LPM)					

6 OUTLET VALVE					
Flow Rate, GPM	20	40	60	80	100
PSI Loss	3.0	4.0	6.0	9.0	11.0
Pressure Range: 25 - 150 PSI (1,7 to 10,3 bar)					
Flow Range: 15-150 GPM (57-568 LPM)					



# Reclaimed Water (RCW) Series

Rotors, Sprays and Indexing Valves for Reclaimed Water

**K-Rain® is a leading manufacturer of rotors, sprays and distribution valves for the reclaimed water industry.**

The K-Rain® RCW series is designed specifically for use on reclaimed water systems. Flexibility in system design, achieved through a wide selection of nozzles, guarantees matched precipitation.

## Features

### RCW ROTORS

- Heavy Duty Rubber Cover (purple) – Seals out dirt and increases product durability, positively identifies the use of reclaimed water reducing liability. Not available on Mini-Pro
- Accepts Low Angle Nozzle – Ensures the correct trajectory of reclaimed water - Not available on Mini-Pro

### RCW INDEXING VALVES

- Available in 4 and 6 Outlet Models – Watering zones can be changed quickly and easily
- 4000 RCW Indexing Valve – Automates multiple zoned residential and small commercial wastewater systems
- 6000 RCW Indexing Valve – Metal die-cast body is capable of high pressure applications.



MiniPro®

RPS™ 75

RPS™ 75i

RPS™ Select

SuperPro®

ProPlus®

ProSport®

Pro-S™

K-Spray™

## Models

Please refer to product pages for individual product model numbers and performance data.

PRODUCT	PAGE
MiniPro®	04
RPS™ 75	08
RPS™ 75i	10
RPS™ Select	14
SuperPro®	16
ProPlus®	20
ProSport®	22
Pro-S™	28
K-Spray™	31
4000 Series Valves	70
6000 Series Valves	71

4000 Series  
Indexing Valves



6000 Series  
Indexing Valves



# Custom Products

Build your brand

Leave a lasting reminder of your company on each job with customized irrigation products. Your logo, phone and/or web address can appear on the products below - FREE - with minimum order requirement AND Premier Contractor membership.



## Requirements

Enrollment in the K-Rain Premier Contractor Program is required for first time custom products purchases.

Not a member? Visit: [premier.krain.com](http://premier.krain.com) or use your smartphone camera to scan this code on the opposite page and sign up.

### ROTORS (RPS 75, RPS 75I AND SUPERPRO)

- Minimum purchase of one unmixed pallet (1,080 rotors) of RPS 75, RPS 75i or SuperPro rotors from your distributor
- Subsequent purchases will require ½ pallets

### LASER-PRINTED CONTROLLER DOORS (PRO EX AND PRO-LC)

- Minimum purchase of one case of controllers from your distributor

### PRO-S SPRAY NOZZLE GUARD

- Minimum purchase of one pallet of Pro-S Sprays with Nozzle Guard from your distributor

### PRO-S SPRAY TWIST CAP

- Minimum purchase of one pallet of Pro-S Sprays from your distributor

## How it works

- Submit your company logo, phone number and/or web address to [customer.service@krain.com](mailto:customer.service@krain.com)
- K-Rain will provide a proof for your approval before production begins

# Premier Contractor Loyalty Program



Earn cash rebates from your very first purchase.

[www.krain.com](http://www.krain.com)



K-Rain offers the most generous loyalty program in the industry. The Premier Contractor Program is our way of saying thanks for your business. The program is simple and the rewards great.

## Rebates can be redeemed for:

- Distributor credit towards your next purchase of K-Rain products
- Debit cards

As a Premier Contractor you will also receive other benefits of membership to help you build your business

- Free product customization (see page 74 for customizable products)
- Homeowner referrals – leads for installations in your area
- Access to complimentary online marketing tools

## Enrollment is easy.

Scan this QR code with your smartphone or tablet and be taken to the online sign up page. Or visit [www.premier.krain.com](http://www.premier.krain.com).



***Join today and begin reaping the rewards!***

# Design Resources

For irrigation Professionals

The K-Rain® website, [www.krain.com](http://www.krain.com) is a resource for product manuals, videos, FAQs and other valuable information. But it also is an online tool for design and installation of our products. Whether you are a landscape architect, irrigation designer or other irrigation professional, K-Rain® has developed libraries to help you quickly find the information you need. Visit the site for CAD detail drawing and irrigation designs for sports fields and more.

## CAD DETAIL DRAWINGS

[WWW.KRAIN.COM/CAD-DETAIL-DRAWINGS](http://WWW.KRAIN.COM/CAD-DETAIL-DRAWINGS)

Lay out your irrigation design effectively and efficiently. We offer 2 file formats for each part number for your convenience. PDF and CAD, or computer-aided design (CAD) for:

- Irrigation Controllers & Rain Sensor
- Rotors
- Pro-ST™ Sprays
- Pro-ST™ Sprays with Rotary Nozzles
- Valves

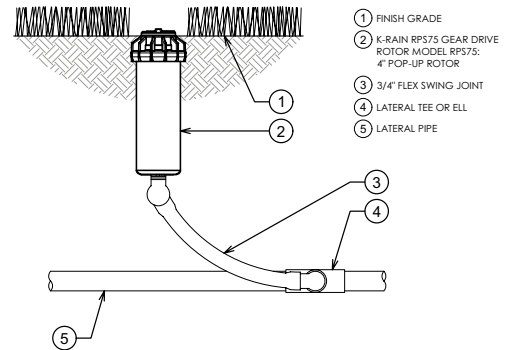

**00** K-RAIN RPS75 ROTOR WITH 4" POP-UP  
3" = 1'-0" [www.krain.com](http://www.krain.com)

## IRRIGATION DESIGNS FOR SPORTS FIELDS

[WWW.KRAIN.COM/SPORTS-FIELD-DESIGN](http://WWW.KRAIN.COM/SPORTS-FIELD-DESIGN)

Our Sports Field Irrigation Designs contain Irrigation Design Criteria for water source and head layouts. There you will find pressure and flow water requirements along with general head spacing by field type. A graphic scale is provided on each field type.

- Baseball
  - Baseball Field-5 Row
- Football
  - Football Field-4 Row
  - Football Field-5 Row
- Little League Field
  - Little League Field-3 Row
- Soccer
  - Soccer Field-5 Row
  - Soccer Field-6 Row (ProSport)
  - Soccer Field-6 Row (RPS75i)
- Tennis
  - Double Tennis Court-3 Row

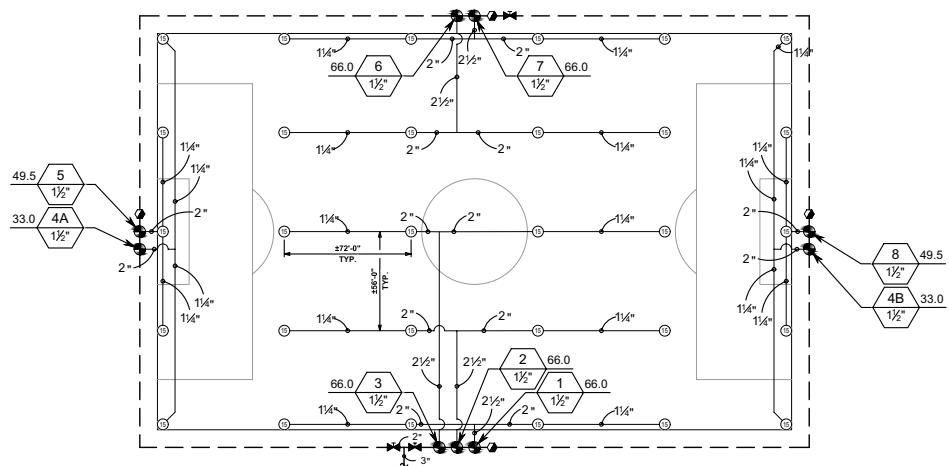

## Conversion Table for U.S. and Metric Systems

METRIC TO U.S.				
MULTIPLY		TO OBTAIN		
Millimeters (mm)	x	.03937	=	inches
Centimeters (cm)	x	.3937	=	inches
Meters (m)	x	39.37	=	inches
Meters (m)	x	3.281	=	feet
Meters (m)	x	1.094	=	yards
Kilometers (km)	x	.62137	=	miles
Kilometers (km)	x	1093.62	=	yards
Kilometers (km)	x	3280.87	=	feet
Liters (l)	x	1.0567	=	quarts (liq.)
Liters (l)	x	.2642	=	gallons (U.S.)
Liters (l)	x	.455	=	pounds
Temp. in (C° x 1.80)	+	32°	=	temp. in F°

U.S. TO METRIC				
MULTIPLY		TO OBTAIN		
Inches (in.)	x	25.4	=	millimeters
Inches (in.)	x	2.54	=	centimeters
Inches (in.)	x	.0254	=	meters
Feet (ft.)	x	.3048	=	meters
Yards (yds.)	x	.9144	=	meters
Miles (mi.)	x	1.6093	=	kilometers
Yards (yds.)	x	.0009143	=	kilometers
Feet (ft.)	x	.0003048	=	kilometers
Quarts (qts.)	x	.945	=	liters
Gallons	x	3.78	=	liters
Pounds	x	2.2	=	liters
Temp. in F° - 32°	x	.5666	=	temp. in C°

<b>Kilograms per cubic centimeter (kg/cm<sup>3</sup>)</b>	<b>x</b>	<b>14.223</b>	<b>=</b>	<b>Pounds per square inch (P.S.I.)</b>
<b>Cubic Foot (cu. ft.) x 28.316</b>			<b>=</b>	<b>Liters (l.)</b>

MISCELLANEOUS CONVERSION FACTORS					
Feet head (ft. hd.) x .433	=	Pounds per square inch (P.S.I.)	Calorie x 3.968	=	British Thermal Unit (B.T.U.)
Pounds per square inch x 2.31	=	Feet head	Foot pounds per second x .7373	=	Watts
Meters x 3.28	=	Feet head	Kilowatts x 1.34	=	Horsepower
Inches of mercury x1.133	=	Feet head	Square foot x 144	=	Square inches
U.S. gallons per minute x .1337	=	Cubic feet per minute	Square yard x 9	=	Square feet
Cubic feet per minute x 7.48	=	U.S. gallons per minute	Acre x 4.840	=	Square yards
British Imperial gallon x 1.201	=	U.S. gallons	Acre x 43,560	=	Square feet
Acre inches per hour x 453	=	G.P.M.	Square mile (section) x 640	=	Acres
Acre foot per day x226	=	G.P.M.	Mile x 5280	=	Feet
1,000,000 gallons per day	=	694 G.P.M.	Cubic yard x 27	=	Cubic Feet
U.S. gallons x .833	=	British Imperial gallon	Circumference of circe x .3183	=	Diameter of circle
U.S. gallon x 8.336	=	Pounds	Diameter of circe x 3.1416	=	Circumference of circle
Acre foot x 325,850	=	U.S. gallons	Diameter of circle squared x .7854	=	Area of circle
Gallons per day x 1,000,000	=	694 gallons per minute	Radius of circle squared x 3.1416	=	Area of circle
U.S. gallons x 231	=	Cubic inches	Cubic Feet per second x 448.8	=	U.S. gallons per minute
Horsepower (H.P.) x 746	=	Watts	Cubic feet per second	=	Gallons per minute - 449
Horsepower x .746	=	Kilowatts	Velocity in feet per second	=	$\frac{.408 \times \text{U.S. g.p.m.}}{\text{Diam. of pipe squared}}$ or $\frac{144Q (\text{flow in G.P.M.})}{A1 (\text{Pipe ID}^2)}$

# Charts

## Resistance and Valve Wire Sizing

### Resistance Method

#### REQUIRED INFORMATION

- Actual one-way length of wire between the controllers and at the power source of the controllers and valves
- Allowable voltage loss along the wire circuit
- Accumulative current flowing through the wire section being sized in amperes

#### RESISTANCE IS CALCULATED USING FORMULA:

$$R = \frac{1000 \times AVL}{2L \times I}$$

R = Maximum Allowable Resistance of wire in ohms per 1000 feet

AVL = Allowable voltage loss

L = Wire length (one way)

I = Inrush current

AVL for controller power wire sizing is calculated by subtracting minimum operating voltage required by the controller from minimum available voltage at power source. AVL for valve wire sizing is calculated by subtracting minimum solenoid operating voltage from controller output voltage. This number will vary depending on the manufacturer and in some cases with line pressure.

### Valve Wire Sizing Example:

**Given:** Distance from the controller to the valve is 1800 ft. Controller output is 24V. The valve has a minimum operating voltage of 20V and an inrush current of 370 mA (0.37Amps).

$$R = \frac{1000 \times 4}{2(1800) \times 0.37} \quad R = \frac{4000}{332} \quad R = \frac{3.00 \text{ ohms/}}{1000 \text{ feet}}$$

Wire resistance can not exceed 3.00 ohms per 1000 feet. Go to table #1 and select the proper wire size. Since 16 gauge wire has more resistance than 3.00 ohms per 1000 feet, choose 14 gauge wire. Table 2 is a quick reference and is set up to provide maximum wire runs given the information at the bottom of the table.

WIRE SIZE AWG No.	Resistance at 20° C (68° F) ohms per 1000 Feet
18	6.39
16	4.02
14	2.52
12	1.59
10	1.00
8	0.63
6	0.40
4	0.25

GROUND WIRE	CONTROL WIRE						
	18	16	14	12	10	8	6
18	850	1040	1210	1350	1460	1540	1590
16	1040	1340	1650	1920	2150	2330	2440
14	1210	1650	2150	2630	3080	3450	3700
12	1350	1920	2630	3390	4170	4880	5400
10	1460	2150	3080	4170	5400	6670	7690
8	1540	2330	3450	4880	6670	8700	10530
6	1590	2440	3700	5400	7690	10530	13330

Solenoid: 24VAC, Pressure: 150 PSI, Voltage Drop: 4V, Min. Operating Voltage: 20V, Amperage Peak: .37A

	(U.S.)	(METRIC)
Equilateral Triangular Spacing	P.R.= (in/hr) $\frac{(GPM \text{ of } 360) \times 96.25}{(\text{Head Spacing})^2 \times .866}$	P.R.= (mm/hr) $\frac{m3/hr \text{ of } 360 \times 1000}{m2 \times .866}$
Square/Rectangular Spacing	P.R.= (in/hr) $\frac{(GPM \text{ of } 360) \times 96.25}{\text{Head Spacing} \times \text{Row Spacing}}$	P.R.= (mm/hr) $\frac{m3/hr \text{ of } 360 \times 1000}{\text{Head Spacing} \times \text{Row Spacing}}$
Square/Rectangular Spacing for Specific Arc	P.R.= (in/hr) $\frac{3460 \times GPM \text{ (for any arc)}}{\text{Degrees of Arc} \times \text{Head Spacing} \times \text{Row Spacing}}$	P.R.= (mm/hr) $\frac{m3/hr \text{ (for any arc)} \times 1000}{\text{Degrees of Arc} \times \text{Head Spacing} \times \text{Row Spacing}}$
Horsepower	H.P. = $\frac{GPM \times Ft \text{ of Head}}{3,960 \times \text{Pump Efficiency (expressed as a decimal)}}$	
Station Run Time	S.R.T. = (min/wk) $\frac{\text{Total Weekly Req'd (inch/wk)} \times 60 \text{ (min/hr)}}{\text{Precipitation Rate (in/hr)}}$	S.R.T.= (min/wk) $\frac{\text{Total Weekly Req'd (mm/wk)} \times 60 \text{ (min/hr)}}{\text{Precipitation Rate (mm/hr)}}$
Pipe Velocity	V= (ft/sec) $\frac{0.4085 \times \text{Flow (GPM)}}{(\text{Inside Pipe Diameter in Inches})^2}$	V= (m/sec) $\frac{1273.24 \times \text{Flow (l/sec)}}{(\text{Inside Pipe Diameter in Millimeters})^2}$
Scheduling Coefficient	S.C.= $\frac{\text{Average Precipitation Rate (in/hr)}}{\text{Lowest Precipitation Rate (in/hr)}}$	S.C.= $\frac{\text{Average Precipitation Rate (mm/hr)}}{\text{Lowest Precipitation Rate (mm/hr)}}$
Slope	S= $\frac{\text{Rise (Measure of Length)}}{\text{Run (Measure of Length)}}$	





# PVC Schedule 40 IPS Plastic Pipe

**SIZES:** 1/2" – 6" **FLOW:** 1 – 600 GPM **PSI LOSS:** Per 100' of tube (PSI/100 FT) **C = 150** (1120, 1220)

SIZE	1/2"		3/4"		1"		1 1/4"		1 1/2"		2"		2 1/2"		3"		4"		6"	
OD	0.840		1.050		1.315		1.660		1.900		2.375		2.875		3.500		4.500		6.625	
ID	0.622		0.824		1.049		1.380		1.610		2.067		2.469		3.068		4.026		6.065	
WALL THK.	0.109		0.113		0.133		0.140		0.145		0.154		0.203		0.216		0.237		0.280	
FLOW G. P. M.	Velocity FPS	psi Loss	Velocity FPS	psi Loss	Velocity FPS	psi Loss	Velocity FPS	psi Loss	Velocity FPS	psi Loss	Velocity FPS	psi Loss	Velocity FPS	psi Loss	Velocity FPS	psi Loss	Velocity FPS	psi Loss	Velocity FPS	psi Loss
1	1.05	0.43	0.60	0.11	0.37	0.03	0.21	0.01	0.15	0.00										
2	2.11	1.55	1.20	0.39	0.74	0.12	0.42	0.03	0.31	0.02	0.19	0.00								
3	3.16	3.28	1.80	0.84	1.11	0.26	0.64	0.07	0.47	0.03	0.28	0.01	0.20	0.00						
4	4.22	5.60	2.40	1.42	1.48	0.44	0.85	0.12	0.62	0.05	0.38	0.02	0.26	0.01						
5	5.27	8.46	3.00	2.15	1.85	0.66	1.07	0.18	0.78	0.08	0.47	0.02	0.33	0.01	0.21	0.00				
6	6.33	11.86	3.60	3.02	2.22	0.93	1.28	0.25	0.94	0.12	0.57	0.03	0.40	0.01	0.26	0.01				
7	7.38	15.77	4.20	4.01	2.59	1.24	1.49	0.33	1.10	0.15	0.66	0.05	0.46	0.02	0.30	0.01				
8	8.44	20.20	4.80	5.14	2.96	1.59	1.71	0.42	1.25	0.20	0.76	0.06	0.53	0.02	0.34	0.01				
9	9.49	25.12	5.40	6.39	3.33	1.97	1.92	0.52	1.41	0.25	0.85	0.07	0.60	0.03	0.39	0.01				
10	10.55	30.54	6.00	7.77	3.70	2.40	2.14	0.63	1.57	0.30	0.95	0.09	0.66	0.04	0.43	0.01				
11	11.60	36.43	6.60	9.27	4.07	2.86	2.35	0.75	1.73	0.36	1.05	0.11	0.73	0.04	0.47	0.02				
12	12.65	42.80	7.21	10.89	4.44	3.36	2.57	0.89	1.88	0.42	1.14	0.12	0.80	0.05	0.52	0.02	0.30	0.00		
14	14.76	56.94	8.41	14.48	5.19	4.47	2.99	1.18	2.20	0.56	1.33	0.17	0.93	0.07	0.60	0.02	0.35	0.01		
16	16.87	72.92	9.61	18.55	5.93	5.73	3.42	1.51	2.51	0.71	1.52	0.21	1.07	0.09	0.69	0.03	0.40	0.01		
18	18.98	90.69	10.81	23.07	6.67	7.13	3.85	1.88	2.83	0.89	1.71	0.26	1.20	0.11	0.78	0.04	0.45	0.01		
20	21.09	110.23	12.01	28.04	7.41	8.66	4.28	2.28	3.14	1.08	1.90	0.32	1.33	0.13	0.86	0.05	0.50	0.01		
22			13.21	33.45	8.15	10.33	4.71	2.72	3.46	1.29	2.10	0.38	1.47	0.16	0.95	0.06	0.55	0.01		
24			14.42	39.30	8.89	12.14	5.14	3.20	3.77	1.51	2.29	0.45	1.60	0.19	1.04	0.07	0.60	0.02		
26			15.62	45.58	9.64	14.08	5.57	3.17	4.09	1.75	2.48	0.52	1.74	0.22	1.12	0.08	0.65	0.02		
28			16.82	52.28	10.38	16.15	5.99	4.25	4.40	2.01	2.67	0.60	1.87	0.25	1.21	0.09	0.70	0.02		
30			18.02	59.41	11.12	18.35	6.42	4.83	4.72	2.28	2.86	0.68	2.00	0.29	1.30	0.10	0.75	0.03		
35					12.97	24.42	7.49	6.43	5.50	3.04	3.34	0.90	2.34	0.38	1.51	0.13	0.88	0.04	0.38	0.00
40					14.83	31.27	8.56	8.23	6.29	3.89	3.81	1.15	2.67	0.49	1.73	0.17	1.00	0.04	0.44	0.01
45					16.68	38.89	9.64	10.24	7.08	4.84	4.29	1.43	3.01	0.60	1.95	0.21	1.13	0.06	0.49	0.01
50					18.53	47.27	10.71	12.45	7.87	5.88	4.77	1.74	3.34	0.73	2.16	0.26	1.25	0.07	1.55	0.01
55							11.78	14.85	8.65	7.01	5.25	2.08	3.68	0.88	2.38	0.30	1.38	0.08	0.61	0.01
60							12.85	17.45	9.44	8.24	5.72	2.44	4.01	1.03	2.60	0.36	1.51	0.10	0.66	0.01
65							13.92	20.23	10.23	9.56	6.20	2.83	4.35	1.19	2.81	0.41	1.63	0.11	0.72	0.02
70							14.99	23.21	11.01	10.96	6.68	3.25	4.68	1.37	3.03	0.48	1.76	0.13	0.77	0.02
75							16.06	26.37	11.80	12.46	7.16	3.69	5.01	1.56	3.25	0.54	1.88	0.14	0.83	0.02
80							17.13	29.72	12.59	14.04	7.63	4.16	5.35	1.75	3.46	0.61	2.01	0.16	0.88	0.02
85							18.21	33.26	13.37	15.71	8.11	4.66	5.68	1.96	3.68	0.68	2.13	0.18	0.94	0.02
90							19.28	36.97	14.16	17.46	8.59	5.18	6.02	2.18	3.90	0.76	2.26	0.20	0.99	0.03
95									14.95	19.30	9.07	5.72	6.35	2.41	4.11	0.84	2.39	0.22	1.05	0.03
100									15.74	21.22	9.54	6.29	6.69	2.65	4.33	0.92	2.51	0.25	1.10	0.03
110									17.31	25.32	10.50	7.51	7.36	3.16	4.76	1.10	2.76	0.29	1.22	0.04
120									18.88	29.75	11.45	8.82	8.03	3.72	5.20	1.29	3.02	0.34	1.33	0.05
130											12.41	10.23	8.70	4.31	5.63	1.50	3.27	0.40	1.44	0.05
140											13.36	11.74	9.37	4.94	6.06	1.72	3.52	0.46	1.55	0.06
150											14.32	13.33	10.03	5.62	6.50	1.95	3.77	0.52	1.66	0.07
160											15.27	15.03	10.70	6.33	6.93	2.20	4.02	0.59	1.77	0.08
170											16.23	16.81	11.37	7.08	7.36	2.46	4.27	0.66	1.88	0.09
180											17.18	18.69	12.04	7.87	7.80	2.74	4.53	0.73	1.99	0.10
190											18.14	20.66	12.71	8.70	8.23	3.02	4.78	0.81	2.10	0.11
200											19.09	22.72	13.38	9.57	8.66	3.33	5.03	0.89	2.21	0.12
225													15.05	11.90	9.75	4.14	5.66	1.10	2.49	0.15
250													16.73	14.47	10.83	5.03	6.29	1.34	2.77	0.18
275													18.40	17.26	11.92	6.00	6.92	1.60	3.05	0.22
300															13.00	7.05	7.55	1.88	3.32	0.26
325															14.08	8.17	8.18	2.18	3.60	0.30
350															15.17	9.38	8.81	2.50	3.88	0.34
375															16.25	10.65	9.43	2.84	4.15	0.39
400															17.33	12.01	10.06	3.20	4.43	0.44
425															18.42	13.43	10.69	3.58	4.71	0.49
450															19.50	14.93	11.32	3.98	4.99	0.54
475																	11.95	4.40	5.26	0.60
500																	12.58	4.84	5.54	0.66
550																	13.84	5.77	6.10	0.79
600																	15.10	6.78	6.65	0.92

Note: Shaded areas of the chart indicate velocities over 5 feet per second (FPS). Use with caution.

# Charts

## PVC Schedule 80 IPS Plastic Pipe

SIZES: 1/2" – 6" FLOW: 1 – 600 GPM PSI LOSS: Per 100' of tube (PSI/100 FT) C = 150 (1120, 1220)

SIZE	1/2"		3/4"		1"		1 1/4"		1 1/2"		2"		2 1/2"		3"		4"		6"	
OD	0.840		1.050		1.315		1.660		1.900		2.375		2.875		3.500		4.500		6.625	
ID	0.546		0.742		0.957		1.278		1.500		1.939		2.323		2.900		3.826		5.761	
WALL THK.	0.147		0.154		0.179		0.191		0.200		0.218		0.276		0.300		0.337		0.432	
FLOW G. P. M.	Velocity FPS	psi Loss	Velocity FPS	psi Loss	Velocity FPS	psi Loss	Velocity FPS	psi Loss	Velocity FPS	psi Loss	Velocity FPS	psi Loss	Velocity FPS	psi Loss	Velocity FPS	psi Loss	Velocity FPS	psi Loss	Velocity FPS	psi Loss
1	1.36	0.81	0.74	0.18	0.44	0.05	0.24	0.01	0.18	0.01	0.10	0.00								
2	2.73	2.92	1.48	0.66	0.89	0.19	0.49	0.05	0.36	0.02	0.21	0.01	0.15	0.00						
3	4.10	6.19	2.22	1.39	1.33	0.40	0.74	0.10	0.54	0.05	0.32	0.01	0.22	0.01						
4	5.47	10.54	2.96	2.37	1.78	0.69	0.99	0.17	0.72	0.08	0.43	0.02	0.30	0.01						
5	6.84	15.93	3.70	3.58	2.22	1.04	1.24	0.25	0.90	0.12	0.54	0.03	0.37	0.01	0.24	0.00				
6	8.21	22.33	4.44	5.02	2.67	1.46	1.49	0.36	1.08	0.16	0.65	0.05	0.45	0.02	0.29	0.01				
7	9.58	29.71	5.18	6.68	3.11	1.94	1.74	0.47	1.26	0.22	0.75	0.06	0.52	0.03	0.33	0.01				
8	10.94	38.05	5.92	8.56	3.56	2.48	1.99	0.61	1.45	0.28	0.86	0.08	0.60	0.03	0.38	0.01				
9	12.31	47.33	6.66	10.64	4.00	3.09	2.24	0.76	1.63	0.35	0.97	0.10	0.68	0.04	0.43	0.01				
10	13.68	57.52	7.41	12.93	4.45	3.75	2.49	0.92	1.81	0.42	1.08	0.12	0.75	0.05	0.48	0.02	0.27	0.00		
11	15.05	68.63	8.15	15.43	4.90	4.47	2.74	1.10	1.99	0.50	1.19	0.14	0.83	0.06	0.53	0.02	0.30	0.01		
12	16.42	80.63	8.89	18.13	5.34	5.26	2.99	1.29	2.17	0.59	1.30	0.17	0.90	0.07	0.58	0.02	0.33	0.01		
14			10.37	24.12	6.23	6.99	3.49	1.71	2.53	0.79	1.51	0.23	1.05	0.09	0.67	0.03	0.39	0.01		
16			11.85	30.88	7.12	8.95	3.99	2.19	2.90	1.01	1.73	0.29	1.20	0.12	0.77	0.04	0.44	0.01		
18			13.33	38.41	8.01	11.14	4.49	2.73	3.26	1.26	1.95	0.36	1.36	0.15	0.87	0.05	0.50	0.01		
20			14.82	46.69	8.90	13.54	4.99	3.31	3.62	1.52	2.17	0.44	1.51	0.18	0.97	0.06	0.55	0.02		
22			16.30	55.70	9.80	16.15	5.49	3.95	3.98	1.81	2.38	0.52	1.66	0.22	1.06	0.07	0.61	0.02		
24			17.78	65.44	10.69	18.97	5.99	4.64	4.35	2.13	2.60	0.61	1.81	0.25	1.16	0.09	0.66	0.02		
26			19.26	75.90	11.58	22.01	6.49	5.39	4.71	2.47	2.82	0.71	1.96	0.29	1.26	0.10	0.72	0.03		
28			12.47	25.24	6.99	6.18	5.07	2.83	3.03	0.81	2.11	0.34	1.35	0.11	0.78	0.03				
30					13.36	28.69	7.49	7.02	5.43	3.22	3.25	0.92	2.26	0.38	1.45	0.13	0.83	0.03	0.36	0.00
35					15.59	38.16	8.74	9.34	6.34	4.29	3.79	1.23	2.64	0.51	1.69	0.17	0.97	0.05	0.43	0.01
40					17.81	48.87	9.99	11.96	7.25	5.49	4.34	1.57	3.02	0.65	1.94	0.22	1.11	0.06	0.49	0.01
45							11.24	14.88	8.16	6.83	4.88	1.96	3.40	0.81	2.18	0.28	1.25	0.07	0.55	0.01
50							12.49	18.09	9.06	8.30	5.42	2.38	3.78	0.99	2.42	0.34	1.39	0.09	0.61	0.01
55							13.73	21.58	9.97	9.90	5.96	2.84	4.15	1.18	2.66	0.40	1.53	0.10	0.67	0.01
60							14.98	25.35	10.87	11.63	6.51	3.33	4.53	1.38	2.91	0.47	1.67	0.12	0.73	0.02
65							16.23	29.40	11.78	13.49	7.05	3.87	4.91	1.61	3.15	0.55	1.81	0.14	0.79	0.02
70							17.48	33.72	12.69	15.47	7.59	4.44	5.29	1.84	3.39	0.63	1.95	0.16	0.86	0.02
75							18.73	38.32	13.59	17.58	8.13	5.04	5.67	2.09	3.63	0.71	2.09	0.18	0.92	0.03
80							19.98	43.19	14.50	19.81	8.68	5.68	6.04	2.36	3.88	0.80	2.22	0.21	0.98	0.03
85									15.41	22.16	9.22	6.36	6.42	2.63	4.12	0.90	2.36	0.23	1.04	0.03
90									16.32	24.64	9.76	7.07	6.80	2.93	4.36	1.00	2.50	0.26	1.10	0.04
95									17.22	27.23	10.30	7.81	7.18	3.24	4.60	1.10	2.64	0.29	1.16	0.04
100									18.13	29.95	10.85	8.59	7.56	3.57	4.85	1.21	2.78	0.31	1.22	0.04
110									19.94	35.73	11.93	10.25	8.31	4.25	5.33	1.45	3.06	0.38	1.35	0.05
120											13.02	12.04	9.07	5.00	5.82	1.70	3.34	0.44	1.47	0.06
130											14.10	13.96	9.82	5.60	6.30	1.97	3.62	0.51	1.59	0.07
140											15.19	16.02	10.58	6.65	6.79	2.27	3.90	0.59	1.72	0.08
150											16.27	18.20	11.34	7.56	7.27	2.57	4.18	0.67	1.84	0.09
160											17.36	20.51	12.09	8.51	7.76	2.89	4.45	0.75	1.96	0.10
170											18.44	22.95	12.85	9.53	8.24	3.24	4.73	0.84	2.08	0.11
180											19.53	25.51	13.60	10.59	8.73	3.60	5.01	0.93	2.21	0.13
190													14.36	11.71	9.21	3.98	5.29	1.03	2.33	0.14
200													15.12	12.87	9.70	4.37	5.57	1.14	2.45	0.16
225													17.01	16.01	10.91	5.44	6.27	1.41	2.76	0.19
250													18.90	19.46	12.12	6.61	6.96	1.72	3.07	0.23
275															13.34	7.89	7.66	2.05	3.38	0.28
300															14.55	9.27	8.36	2.41	3.68	0.33
325															15.76	10.75	9.05	2.79	3.99	0.38
350															16.97	12.33	9.75	3.20	4.30	0.44
375															18.19	14.01	10.45	3.64	4.60	0.50
400															19.40	15.79	11.14	4.10	4.91	0.56
425																	11.84	4.59	5.22	0.63
450																	12.54	5.10	5.53	0.70
475																	13.23	5.64	5.83	0.77
500																	13.93	6.20	6.14	0.85
550																	15.32	7.40	6.76	1.01
600																	16.72	8.69	7.37	1.19

Note: Shaded areas of the chart indicate velocities over 5 feet per second (FPS). Use with caution.

Velocity of flow rate values are computed from the general equation  $V = .408 Q/d^2$

Friction pressure loss values are computed from the equation  $[hf = 0.2083 (100/C) 1.852 Q^{1.852}/d^{4.868}] \times 4.33$  for psi loss per 100' of pipe.

# PVC Class 125 IPS Plastic Pipe

**SIZES:** 1" – 6" **FLOW:** 1 – 600 GPM **PSI LOSS:** Per 100' of tube (PSI/100 FT) **C = 150** (1120, 1220) SDR 32.5

SIZE	1"		1 1/4"		1 1/2"		2"		2 1/2"		3"		4"		6"	
OD	1.315	1.660	1.900	2.375	2.875	3.500	4.500	6.625								
ID	1.211	1.548	1.784	2.229	2.699	3.284	4.224	6.217								
WALL THK.	0.052	0.056	0.058	0.073	0.088	0.108	0.138	0.204								
FLOW G. P. M.	Velocity FPS	psi Loss	Velocity FPS	psi Loss	Velocity FPS	psi Loss	Velocity FPS	psi Loss	Velocity FPS	psi Loss	Velocity FPS	psi Loss	Velocity FPS	psi Loss	Velocity FPS	psi Loss
1	0.27	0.02	0.17	0.01	0.12	0.00										
2	0.55	0.06	0.34	0.02	0.25	0.01	0.16	0.00								
3	0.83	0.13	0.51	0.04	0.38	0.02	0.24	0.01								
4	1.11	0.22	0.68	0.07	0.51	0.03	0.32	0.01	0.22	0.00						
5	1.39	0.33	0.85	0.10	0.64	0.05	0.41	0.02	0.28	0.01						
6	1.66	0.46	1.02	0.14	0.76	0.07	0.49	0.02	0.33	0.01						
7	1.94	0.62	1.19	0.19	0.89	0.09	0.57	0.03	0.39	0.01	0.26	0.00				
8	2.22	0.79	1.36	0.24	1.02	0.12	0.65	0.04	0.44	0.02	0.30	0.01				
9	2.50	0.98	1.53	0.30	1.15	0.15	0.73	0.05	0.50	0.02	0.34	0.01				
10	2.78	1.19	1.70	0.36	1.28	0.18	0.82	0.06	0.56	0.02	0.37	0.01				
11	3.06	1.42	1.87	0.43	1.41	0.22	0.90	0.07	0.61	0.03	0.41	0.01				
12	3.33	1.67	2.04	0.51	1.53	0.25	0.98	0.09	0.67	0.03	0.45	0.01	0.27	0.00		
14	3.89	2.22	2.38	0.67	1.79	0.34	1.14	0.11	0.78	0.05	0.52	0.02	0.32	0.01		
16	4.45	2.85	2.72	0.86	2.05	0.43	1.31	0.15	0.89	0.06	0.60	0.02	0.36	0.01		
18	5.00	3.54	3.06	1.07	2.30	0.54	1.47	0.18	1.00	0.07	0.68	0.03	0.41	0.01		
20	5.56	4.31	3.40	1.30	2.56	0.65	1.64	0.22	1.12	0.09	0.75	0.03	0.45	0.01		
22	6.12	5.14	3.74	1.56	2.82	0.78	1.80	0.26	1.23	0.10	0.83	0.04	0.50	0.01		
24	6.67	6.04	4.08	1.83	3.07	0.92	1.97	0.31	1.34	0.12	0.90	0.05	0.54	0.01		
26	7.23	7.00	4.42	2.12	3.33	1.06	2.13	0.36	1.45	0.14	0.98	0.05	0.59	0.02		
28	7.78	8.03	4.76	2.43	3.58	1.22	2.29	0.41	1.56	0.16	1.05	0.06	0.644	0.02		
30	8.34	9.13	5.10	2.76	3.84	1.39	2.46	0.47	1.68	0.18	1.13	0.07	0.68	0.02		
35	9.73	12.14	5.95	3.68	4.48	1.84	2.87	0.62	1.96	0.25	1.32	0.09	0.80	0.03	0.36	0.00
40	11.12	15.55	6.81	4.71	5.12	2.36	3.28	0.80	2.24	0.31	1.51	0.12	0.91	0.04	0.42	0.01
45	12.51	19.34	7.66	5.86	5.76	2.94	3.69	0.99	2.52	0.39	1.70	0.15	1.02	0.04	0.47	0.01
50	13.91	23.50	8.51	7.12	6.40	3.57	4.10	1.21	2.80	0.48	1.89	0.18	1.14	0.05	0.52	0.01
55	15.30	28.04	9.36	8.49	7.05	4.26	4.51	1.44	3.08	0.57	2.08	0.22	1.25	0.06	0.58	0.01
60	16.69	32.94	10.21	9.98	7.69	5.00	4.92	1.69	3.36	0.67	2.26	0.26	1.37	0.085	0.63	0.01
65	18.08	38.21	11.06	11.57	8.33	5.80	5.33	1.96	3.64	0.77	2.45	0.30	1.48	0.09	0.68	0.01
70	19.47	43.83	11.91	13.27	8.97	6.65	5.74	2.25	3.92	0.89	2.64	0.34	1.60	0.10	0.73	0.02
75			12.76	15.08	9.61	7.56	6.15	2.56	4.20	1.01	2.83	0.39	1.71	0.11	0.79	0.02
80			13.62	17.00	10.25	8.52	6.56	2.88	4.48	1.14	3.02	0.44	1.82	0.13	0.84	0.02
85			14.47	19.02	10.89	9.53	6.98	3.23	4.76	1.27	3.21	0.49	1.94	0.14	0.89	0.02
90			15.32	21.14	11.53	10.60	7.39	3.59	5.04	1.41	3.40	0.54	2.05	0.16	0.95	0.02
95			16.17	23.37	12.17	11.71	7.80	3.96	5.32	1.56	3.59	0.60	2.17	0.18	1.00	0.03
100			17.02	25.69	12.81	12.88	8.21	4.36	5.60	1.72	3.78	0.66	2.28	0.19	1.05	0.03
110			18.72	3.65	14.10	15.37	9.03	5.20	6.16	2.05	4.16	0.79	2.51	0.23	1.16	0.04
120					15.38	18.06	9.85	6.11	6.72	2.41	4.53	0.93	2.74	0.27	1.26	0.04
130					16.66	20.94	10.67	7.09	7.28	2.79	4.91	1.08	2.97	0.32	1.37	0.05
140					17.94	24.02	11.49	8.13	7.84	3.20	5.29	1.23	3.20	0.36	1.47	0.06
150					19.22	27.30	12.31	9.24	8.40	3.64	5.67	1.40	3.43	0.41	1.58	0.06
160							13.13	10.41	8.96	4.10	6.05	1.58	3.65	0.46	1.68	0.07
170							13.96	11.65	9.52	4.59	6.43	1.77	3.88	0.52	1.79	0.08
180							14.78	12.95	10.08	5.10	6.80	1.96	4.11	0.58	1.90	0.09
190							15.60	14.31	10.64	5.64	7.18	2.17	4.34	0.64	2.00	0.10
200							16.42	15.74	11.20	6.20	7.56	2.39	4.57	0.70	2.11	0.11
225							18.47	19.57	12.60	7.72	8.51	2.97	5.14	0.87	2.37	0.13
250									14.00	9.38	9.45	3.61	5.71	1.06	2.63	0.16
275									15.40	11.19	10.40	4.31	6.28	1.27	2.90	0.19
300									16.80	13.15	11.34	5.06	6.86	1.49	3.16	0.23
325									18.20	15.25	12.29	5.87	7.43	1.72	3.43	0.26
350									19.60	17.49	13.24	6.73	8.00	1.98	3.69	0.30
375											14.18	7.65	8.57	2.25	3.95	0.34
400											15.13	8.62	9.14	2.53	4.22	0.39
425											16.07	9.65	9.71	2.83	4.48	0.43
450											17.02	10.72	10.29	3.15	4.75	0.48
475											17.96	11.85	10.86	3.48	5.01	0.53
500											18.91	13.03	11.43	3.83	5.27	0.58
550													12.57	4.57	5.80	0.70
600													13.72	5.37	6.33	0.82

Note: Shaded areas of the chart indicate velocities over 5 feet per second (FPS). Use with caution.

# Charts

## PVC Class 160 IPS Plastic Pipe

**SIZES:** 1" – 6" **FLOW:** 1 – 600 GPM **PSI LOSS:** Per 100' of tube (PSI/100 FT) **C = 150** (1120, 1220) SDR 26

SIZE	1"		1 1/4"		1 1/2"		2"		2 1/2"		3"		4"		6"	
OD	1.315	1.660	1.900	2.375	2.875	3.500	4.500	6.625								
ID	1.195	1.532	1.754	2.193	2.655	3.230	4.154	6.115								
WALL THK.	0.060	0.064	0.073	0.091	0.110	0.135	0.173	0.225								
FLOW G. P. M.	Velocity FPS	psi Loss	Velocity FPS	psi Loss	Velocity FPS	psi Loss	Velocity FPS	psi Loss	Velocity FPS	psi Loss	Velocity FPS	psi Loss	Velocity FPS	psi Loss	Velocity FPS	psi Loss
1	0.28	0.02	0.17	0.01	0.13	0.00										
2	0.57	0.06	0.34	0.02	0.26	0.01	0.16	0.00								
3	0.85	0.14	0.52	0.04	0.39	0.02	0.25	0.01								
4	1.14	0.23	0.69	0.07	0.53	0.04	0.33	0.01	0.23	0.00						
5	1.42	0.35	0.86	0.11	0.66	0.05	0.42	0.02	0.28	0.01						
6	1.71	0.49	1.04	0.15	0.79	0.08	0.50	0.03	0.34	0.01	0.20	0.00				
7	1.99	0.66	1.21	0.20	0.92	0.10	0.59	0.03	0.40	0.01	0.27	0.01				
8	2.28	0.84	1.39	0.25	1.06	0.13	0.67	0.04	0.46	0.02	0.31	0.01				
9	2.57	1.05	1.56	0.31	1.19	0.16	0.76	0.05	0.52	0.02	0.35	0.01				
10	2.85	1.27	1.73	0.38	1.32	0.20	0.84	0.07	0.57	0.03	0.39	0.01				
11	3.14	1.52	1.91	0.45	1.45	0.23	0.93	0.08	0.63	0.03	0.43	0.01				
12	3.42	1.78	2.085	0.53	1.59	0.28	1.01	0.09	0.69	0.04	0.46	0.01	0.28	0.00		
14	3.99	2.37	2.43	0.71	1.85	0.37	1.18	0.12	0.81	0.05	0.54	0.02	0.33	0.01		
16	4.57	3.04	2.78	0.91	2.12	0.47	1.35	0.16	0.92	0.06	0.62	0.02	0.37	0.01		
18	5.14	3.78	3.12	1.13	2.38	0.58	1.52	0.20	1.04	0.08	0.70	0.03	0.42	0.01		
20	5.71	4.59	3.47	1.37	2.65	0.71	1.69	0.24	1.15	0.09	0.78	0.04	0.47	0.01		
22	6.28	5.48	3.82	1.64	2.91	0.85	1.86	0.29	1.27	0.11	0.86	0.04	0.52	0.01		
24	6.85	6.44	4.17	1.92	3.18	1.00	2.03	0.34	1.38	0.13	0.93	0.05	0.56	0.02		
26	7.42	7.47	4.51	2.23	3.44	1.15	2.20	0.39	1.50	0.15	1.01	0.06	0.61	0.02		
28	7.99	8.57	4.86	2.56	3.71	1.32	2.37	0.45	1.62	0.18	1.09	0.07	0.66	0.02		
30	8.57	9.74	5.21	2.91	3.97	1.50	2.54	0.51	1.73	0.20	1.17	0.08	0.70	0.02		
35	9.99	12.95	6.08	3.87	4.64	2.00	2.96	0.68	2.02	0.27	1.36	0.10	0.82	0.03	0.38	0.00
40	11.42	16.59	6.95	4.95	5.30	2.56	3.39	0.86	2.31	0.34	1.56	0.13	0.94	0.04	0.43	0.01
45	12.85	20.63	7.82	6.16	5.96	3.19	3.81	1.08	2.60	0.42	1.75	0.16	1.06	0.05	0.49	0.01
50	14.28	25.07	8.69	7.49	6.63	3.88	4.24	1.31	2.89	0.52	1.95	0.20	1.18	0.06	0.54	0.01
55	15.71	29.91	9.56	8.93	7.29	4.62	4.66	1.56	3.18	0.62	2.15	0.24	1.30	0.07	0.60	0.01
60	17.14	35.14	10.43	10.49	7.95	5.43	5.09	1.83	3.47	0.72	2.34	0.28	1.41	0.08	0.65	0.01
65	18.57	40.67	11.29	12.17	8.62	6.30	5.51	2.12	3.76	0.84	2.54	0.32	1.53	0.09	0.70	0.01
70	19.99	46.76	12.16	13.96	9.28	7.23	5.93	2.44	4.05	0.96	2.73	0.37	1.65	0.11	0.76	0.02
75			13.03	15.86	9.94	8.21	6.36	2.77	4.34	1.09	2.93	0.42	1.77	0.12	0.81	0.02
80			13.90	17.88	10.60	9.25	6.78	3.12	4.63	1.23	3.12	0.47	1.89	0.14	0.87	0.02
85			14.77	20.00	11.27	10.35	7.21	3.49	4.91	1.38	3.32	0.53	2.00	0.16	0.92	0.02
90			15.64	22.23	11.93	11.51	7.63	3.88	5.20	1.53	3.51	0.59	2.12	0.17	0.98	0.03
95			16.51	24.58	12.59	12.72	8.05	4.29	5.49	1.69	3.71	0.65	2.24	0.19	1.03	0.03
100			17.38	27.03	13.26	13.99	8.48	4.72	5.78	1.86	3.91	0.72	2.36	0.21	1.09	0.03
110			19.12	32.24	14.58	16.69	9.33	5.63	6.36	2.22	4.30	0.86	2.60	0.25	1.20	0.04
120					15.91	19.61	10.18	6.61	6.94	2.61	4.69	1.01	2.83	0.30	1.30	0.05
130					17.24	22.74	11.02	7.67	7.52	3.03	5.08	1.17	3.07	0.34	1.41	0.05
140					18.56	26.09	11.87	8.80	8.10	3.47	5.47	1.34	3.31	0.39	1.52	0.06
150					19.89	29.64	12.72	10.00	8.68	3.94	5.86	1.52	3.54	0.45	1.63	0.07
160							13.57	11.27	9.26	4.45	6.25	1.71	3.78	0.50	1.74	0.08
170							14.42	12.61	9.83	4.97	6.64	1.92	4.01	0.56	1.85	0.09
180							15.27	14.02	10.41	5.53	7.03	2.13	4.25	0.63	1.96	0.10
190							16.11	15.49	10.99	6.11	7.43	2.35	4.49	0.69	2.07	0.11
200							16.96	17.03	11.57	6.72	7.82	2.59	4.72	0.76	2.18	0.12
225							19.08	21.19	13.02	8.36	8.79	3.22	5.31	0.95	2.45	0.14
250									14.47	10.16	9.77	3.91	5.91	1.15	2.72	0.18
275									15.91	12.12	10.75	4.67	6.50	1.37	3.00	0.21
300									17.36	14.24	11.73	5.49	7.09	1.61	3.27	0.25
325									18.81	16.51	12.70	6.36	7.68	1.87	3.54	0.29
350											13.68	7.30	8.27	2.15	3.81	0.33
375											14.66	8.29	8.86	2.44	4.09	0.37
400											15.64	9.35	9.45	2.75	4.36	0.42
425											16.62	10.46	10.04	3.07	4.63	0.47
450											17.59	11.62	10.63	3.42	4.90	0.52
475											18.57	12.85	11.23	3.78	5.18	0.58
500											19.55	14.13	11.82	4.15	5.45	0.63
550													13.00	4.96	6.00	0.76
600													14.18	5.82	6.54	0.89

Note: Shaded areas of the chart indicate velocities over 5 feet per second (FPS). Use with caution.

# PVC Class 200 IPS Plastic Pipe

**SIZES:** 3/4" – 6" **FLOW:** 1 – 600 GPM **PSI LOSS:** Per 100' of pipe (PSI/100 FT) **C = 150** (1120, 1220) SDR 21

SIZE	3/4"		1"		1 1/4"		1 1/2"		2"		2 1/2"		3"		4"		6"	
OD	1.050	1.315	1.660	1.900	2.375	2.875	3.500	4.500	6.625									
ID	0.930	1.189	1.502	1.720	2.149	2.601	3.166	4.072	5.993									
WALL THK.	0.060	0.063	0.079	0.090	0.113	0.137	0.167	0.214	0.316									
FLOW G. P. M.	Velocity FPS	psi Loss	Velocity FPS	psi Loss	Velocity FPS	psi Loss	Velocity FPS	psi Loss	Velocity FPS	psi Loss	Velocity FPS	psi Loss	Velocity FPS	psi Loss	Velocity FPS	psi Loss	Velocity FPS	psi Loss
1	0.47	0.06	0.28	0.02	0.18	0.01	0.13	0.00										
2	0.94	0.22	0.57	0.07	0.36	0.02	0.27	0.01	0.17	0.00								
3	1.42	0.46	0.86	0.14	0.54	0.04	0.41	0.02	0.26	0.01	0.18	0.00						
4	1.89	0.79	1.15	0.24	0.72	0.08	0.55	0.04	0.35	0.01	0.24	0.01						
5	2.36	1.20	1.44	0.36	0.90	0.12	0.68	0.06	0.44	0.02	0.30	0.01						
6	2.83	1.68	1.73	0.51	1.08	0.16	0.82	0.08	0.53	0.03	0.36	0.01	0.24	0.00				
7	3.30	2.23	2.02	0.67	1.26	0.22	0.96	0.11	0.61	0.04	0.42	0.01	0.28	0.01				
8	3.77	2.85	2.30	0.86	1.44	0.28	1.10	0.14	0.70	0.05	0.48	0.02	0.32	0.01				
9	4.25	3.55	2.59	1.07	1.62	0.34	1.24	0.18	0.79	0.06	0.54	0.02	0.36	0.01				
10	4.72	4.31	2.88	1.30	1.80	0.42	1.37	0.22	0.88	0.07	0.60	0.03	0.40	0.01				
11	5.19	5.15	3.17	1.56	1.98	0.50	1.51	0.26	0.97	0.09	0.66	0.03	0.44	0.01				
12	5.66	6.05	3.46	1.83	2.17	0.59	1.65	0.30	1.06	0.10	0.72	0.04	0.48	0.02	0.29	0.00		
14	6.60	8.05	4.04	2.43	2.53	0.78	1.93	0.40	1.23	0.14	0.84	0.05	0.56	0.02	0.34	0.01		
16	7.55	10.30	4.61	3.11	2.89	1.00	2.20	0.52	1.41	0.17	0.96	0.07	0.65	0.03	0.39	0.01		
18	8.49	12.81	5.19	3.87	3.25	1.24	2.48	0.64	1.59	0.22	1.08	0.09	0.73	0.03	0.44	0.01		
20	9.43	15.58	5.77	4.71	3.61	1.51	2.75	0.78	1.76	0.26	1.20	0.10	0.81	0.04	0.49	0.01		
22	10.38	18.58	6.34	5.62	3.97	1.80	3.03	0.93	1.94	0.32	1.32	0.12	0.89	0.05	0.54	0.01		
24	11.32	21.83	6.92	6.60	4.34	2.12	3.30	1.09	2.12	0.37	1.44	0.15	0.97	0.06	0.59	0.02		
26	12.27	25.32	7.50	7.65	4.70	2.46	3.58	1.27	2.29	0.43	1.56	0.17	1.05	0.07	0.63	0.02		
28	13.21	29.04	8.08	8.78	5.06	2.82	3.86	1.46	2.47	0.49	1.68	0.19	1.13	0.07	0.68	0.02		
30	14.15	33.00	8.65	9.98	5.42	3.20	4.13	1.66	2.65	0.56	1.80	0.22	1.22	0.09	0.73	0.02	0.34	0.00
35	16.51	43.91	10.10	13.27	6.32	4.26	4.82	2.20	3.09	0.75	2.11	0.29	1.42	0.11	0.86	0.03	0.39	0.01
40	18.87	56.23	11.54	17.00	7.23	5.45	5.51	2.82	3.53	0.95	2.41	0.38	1.62	0.14	0.98	0.04	0.45	0.01
45			12.98	21.14	8.13	6.78	6.20	3.51	3.97	1.19	2.71	0.47	1.83	0.18	1.10	0.05	0.51	0.01
50			14.42	25.70	9.04	8.24	6.89	4.26	4.41	1.44	3.01	0.57	2.03	0.22	1.23	0.06	0.56	0.01
55			15.87	30.66	9.94	9.83	7.58	5.09	4.85	1.72	3.31	0.68	2.23	0.26	1.35	0.08	0.62	0.01
60			17.31	36.02	10.85	11.55	8.27	5.97	5.30	2.02	3.61	0.80	2.44	0.31	1.47	0.09	0.68	0.01
65			18.75	41.77	11.75	13.40	8.96	6.93	5.74	2.35	3.92	0.93	2.64	0.36	1.59	0.10	0.73	0.02
70					12.65	15.37	9.65	7.95	6.18	2.69	4.22	1.06	2.84	0.41	1.72	0.12	0.79	0.02
75					13.56	17.47	10.34	9.03	6.62	3.06	4.52	1.21	3.05	0.46	1.84	0.14	0.85	0.02
80					14.46	19.68	11.03	10.18	7.06	3.44	4.82	1.36	3.25	0.52	1.96	0.15	0.90	0.02
85					15.37	22.02	11.72	11.39	7.50	3.85	5.12	1.52	3.45	0.59	2.09	0.17	0.96	0.03
90					16.27	24.48	12.41	12.66	7.95	4.28	5.42	1.69	3.66	0.65	2.21	0.19	1.02	0.03
95					17.18	27.06	13.10	13.99	8.39	4.74	5.72	1.87	3.86	0.72	2.33	0.21	1.07	0.03
100					18.08	29.76	13.79	15.39	8.83	5.21	6.03	2.06	4.07	0.79	2.46	0.23	1.13	0.04
110					19.89	35.50	15.17	18.36	9.71	6.21	6.63	2.45	4.47	0.94	2.70	0.28	1.24	0.04
120							16.54	21.57	10.60	7.30	7.23	2.88	4.88	1.11	2.95	0.33	1.36	0.05
130							17.92	25.02	11.48	8.47	7.84	3.34	5.29	1.29	3.19	0.38	1.47	0.06
140							19.30	28.70	12.36	9.71	8.44	3.84	5.69	1.47	3.44	0.43	1.59	0.07
150									13.25	11.04	9.04	4.36	6.10	1.68	3.69	0.49	1.70	0.08
160									14.13	12.44	9.64	4.91	6.51	1.89	3.93	0.55	1.81	0.08
170									15.01	13.91	10.25	5.50	6.91	2.11	4.18	0.62	1.93	0.09
180									15.90	15.47	10.85	6.11	7.32	2.35	4.42	0.69	2.04	0.11
190									16.78	17.10	11.45	6.75	7.73	2.60	4.67	0.76	2.15	0.12
200									17.66	18.80	12.06	7.43	8.14	2.85	4.92	0.84	2.27	0.13
225									19.87	23.38	13.56	9.24	9.15	3.55	5.53	1.04	2.55	0.16
250											15.07	11.23	10.17	4.31	6.15	1.27	2.83	0.19
275											16.58	13.39	11.19	5.15	6.76	1.51	3.12	0.23
300											18.09	15.74	12.21	6.05	7.38	1.78	3.40	0.27
325											19.60	18.25	13.22	7.01	7.99	2.06	3.69	0.31
350													14.24	8.05	8.61	2.36	3.97	0.36
375													15.26	9.14	9.22	2.69	4.25	0.41
400													16.28	10.30	9.84	3.03	4.54	0.46
425													17.29	11.53	10.45	3.396	4.82	0.52
450													18.31	12.81	11.07	3.77	5.11	0.57
475													19.33	14.16	11.68	4.16	5.39	0.63
500															12.30	4.58	5.67	0.70
550															13.53	5.46	6.24	0.83
600															14.76	6.42	6.81	0.98

Note: Shaded areas of the chart indicate velocities over 5 feet per second (FPS). Use with caution.

# Charts

## PVC Class 315 IPS Plastic Pipe

**SIZES:** 1/2" – 6" **FLOW:** 1 – 600 GPM **PSI LOSS:** Per 100' of pipe (PSI/100 FT) **C =** 150 (1120, 1220) SDR 13.5

SIZE	1/2"		3/4"		1"		1 1/4"		1 1/2"		2"		2 1/2"		3"		4"		6"	
	OD	ID	OD	ID	OD	ID	OD	ID	OD	ID	OD	ID	OD	ID	OD	ID	OD	ID	OD	ID
OD	0.840	0.716	1.050	0.894	1.315	1.121	1.660	1.414	1.900	1.618	2.375	2.023	2.875	2.449	3.500	2.982	4.500	3.834	6.625	5.643
WALL THK.	0.062	0.062	0.078	0.078	0.097	0.097	0.123	0.123	0.141	0.141	0.176	0.176	0.213	0.213	0.259	0.259	0.333	0.333	0.491	0.491
FLOW G.P.M.	Velocity FPS	psi Loss	Velocity FPS	psi Loss	Velocity FPS	psi Loss	Velocity FPS	psi Loss	Velocity FPS	psi Loss	Velocity FPS	psi Loss	Velocity FPS	psi Loss	Velocity FPS	psi Loss	Velocity FPS	psi Loss	Velocity FPS	psi Loss
1	0.79	0.22	0.51	0.07	0.32	0.02	0.20	0.01	0.15	0.00										
2	1.59	0.78	1.02	0.27	0.64	0.09	0.40	0.03	0.31	0.01	0.19	0.00								
3	2.38	1.65	1.53	0.56	0.97	0.19	0.61	0.06	0.46	0.03	0.29	0.01	0.20	0.00						
4	3.18	2.82	2.04	0.96	1.29	0.32	0.81	0.10	0.62	0.05	0.39	0.02	0.27	0.01						
5	3.97	4.26	2.55	1.45	1.62	0.48	1.02	0.16	0.77	0.08	0.49	0.03	0.34	0.01	0.22	0.00				
6	4.77	5.97	3.06	2.03	1.94	0.67	1.22	0.22	0.93	0.11	0.59	0.04	0.40	0.02	0.27	0.01				
7	5.57	7.95	3.57	2.70	2.27	0.90	1.42	0.29	1.09	0.15	0.69	0.05	0.47	0.02	0.32	0.01				
8	6.36	10.18	4.08	3.45	2.59	1.15	1.63	0.37	1.24	0.19	0.79	0.06	0.54	0.03	0.36	0.01				
9	7.16	12.66	4.59	4.30	2.92	1.43	1.83	0.46	1.40	0.24	0.89	0.08	0.61	0.03	0.41	0.01				
10	7.95	15.38	5.10	5.22	3.24	1.74	2.04	0.56	1.55	0.29	0.99	0.10	0.68	0.04	0.45	0.01	0.27	0.00		
11	8.75	18.35	5.61	6.23	3.57	2.07	2.24	0.67	1.71	0.35	1.09	0.12	0.74	0.05	0.50	0.02	0.30	0.01		
12	9.55	21.56	6.12	7.32	3.89	2.43	2.44	0.79	1.87	0.41	1.19	0.14	0.81	0.05	0.55	0.02	0.33	0.01		
14	11.14	28.69	7.14	9.74	4.54	3.24	2.85	1.05	2.18	0.54	1.39	0.18	0.95	0.07	0.64	0.03	0.38	0.01		
16	12.73	36.74	8.16	12.47	5.19	4.15	3.26	1.34	2.49	0.70	1.59	0.23	1.08	0.09	0.73	0.04	0.44	0.01		
18	14.32	45.69	9.18	15.51	5.84	5.16	3.67	1.67	2.80	0.87	1.79	0.29	1.22	0.12	0.82	0.04	0.49	0.01		
20	15.91	55.54	10.20	18.86	6.49	6.27	4.08	2.03	3.11	1.05	1.99	0.35	1.36	0.14	0.91	0.05	0.55	0.02		
22	17.50	66.26	11.23	22.50	7.14	7.48	4.48	2.42	3.42	1.25	2.19	0.42	1.49	0.17	1.00	0.06	0.61	0.02		
24	19.10	77.84	12.25	26.43	7.79	8.79	4.89	2.84	3.74	1.47	2.39	0.50	1.63	0.20	1.10	0.08	0.66	0.02		
26			13.27	30.65	8.44	10.19	5.30	3.29	4.05	1.71	2.59	0.58	1.76	0.23	1.19	0.09	0.72	0.03		
28			14.29	35.16	9.09	11.69	5.71	3.78	4.36	1.96	2.79	0.66	1.90	0.26	1.28	0.10	0.77	0.03	0.35	0.00
30			15.31	39.95	9.74	13.29	6.12	4.29	4.67	2.23	2.99	0.75	2.04	0.30	1.37	0.11	0.83	0.03	0.38	0.01
35			17.86	53.15	11.36	17.68	7.14	5.71	5.45	2.96	3.48	1.00	2.38	0.39	1.60	0.15	0.97	0.04	0.44	0.01
40					12.98	22.64	8.16	7.31	6.23	3.80	3.98	1.28	2.72	0.51	1.83	0.19	1.11	0.06	0.51	0.01
45					14.61	28.15	9.18	9.10	7.01	4.72	4.48	1.59	3.06	0.63	2.06	0.24	1.24	0.07	0.57	0.01
50					16.23	34.22	10.20	11.06	7.79	5.74	4.98	1.94	3.40	0.76	2.29	0.29	1.38	0.09	0.64	0.01
55					17.85	40.83	11.22	13.19	8.57	6.85	5.48	2.31	3.74	0.91	2.52	0.35	1.52	0.10	0.70	0.02
60					19.48	47.97	12.24	15.50	9.35	8.04	5.98	2.71	4.08	1.07	2.75	0.41	1.66	0.12	0.76	0.02
65							13.26	17.97	10.13	9.33	6.48	3.15	4.42	1.24	2.98	0.48	1.80	0.14	0.83	0.02
70							14.28	20.62	10.90	10.70	6.97	3.61	4.76	1.42	3.21	0.55	1.94	0.16	0.89	0.02
75							15.30	23.43	11.68	12.16	7.47	4.10	5.10	1.62	3.44	0.62	2.08	0.18	0.96	0.03
80							16.32	26.40	12.46	13.71	7.97	4.62	5.44	1.82	3.67	0.70	2.22	0.21	1.02	0.03
85							17.34	29.54	13.24	15.33	8.47	5.17	5.78	2.04	3.89	0.78	2.35	0.23	1.08	0.04
90							18.36	32.84	14.02	17.05	8.97	5.75	6.12	2.27	4.12	0.87	2.49	0.26	1.15	0.04
95							19.38	36.30	14.80	18.84	9.47	6.35	6.46	2.51	4.35	0.96	2.63	0.28	1.21	0.04
100									15.58	20.72	9.96	6.99	6.80	2.76	4.58	1.06	2.77	0.31	1.28	0.05
110									17.14	24.72	10.96	8.34	7.48	3.29	5.04	1.26	3.05	0.37	1.40	0.06
120									18.70	29.04	11.96	9.79	8.16	3.87	5.50	1.48	3.33	0.44	1.53	0.07
130											12.96	11.36	8.84	4.48	5.96	1.72	3.60	0.51	1.66	0.08
140											13.95	13.03	9.52	5.14	6.42	1.97	3.88	0.58	1.79	0.09
150											14.95	14.81	10.20	5.84	6.88	2.24	4.16	0.66	1.92	0.10
160											15.95	16.69	10.88	6.59	7.34	2.53	4.44	0.74	2.04	0.11
170											16.94	18.67	11.56	7.37	7.79	2.83	4.71	0.83	2.17	0.13
180											17.94	20.75	12.24	8.19	8.25	3.14	4.99	0.93	2.30	0.14
190											18.94	22.94	12.92	9.05	8.71	3.47	5.27	1.02	2.43	0.16
200											19.93	25.23	13.60	9.95	9.17	3.82	5.55	1.12	2.56	0.17
225													15.30	12.38	10.32	4.75	6.24	1.40	2.88	0.21
250													17.00	15.05	11.47	5.77	6.93	1.70	3.20	0.26
275													18.70	17.95	12.61	6.89	7.63	2.03	3.52	0.31
300															13.76	8.09	8.32	2.38	3.84	0.36
325															14.91	9.39	9.02	2.76	4.16	0.42
350															16.05	10.77	9.71	3.17	4.48	0.48
375															17.20	12.23	10.40	3.60	4.80	0.55
400															18.35	13.79	11.10	4.06	5.12	0.62
425															19.49	15.42	11.79	4.54	5.44	0.69
450																	12.49	5.05	5.76	0.77
475																	13.18	5.58	6.08	0.85
500																	13.87	6.14	6.40	0.94
550																	15.26	7.32	7.04	1.12
600																	16.65	8.60	7.68	1.31

Note: Shaded areas of the chart indicate velocities over 5 feet per second (FPS). Use with caution.

# Type K Copper Water Tube

**SIZES:** 1/2" – 3" **FLOW:** 1 – 600 GPM **PSI LOSS:** Per 100' of tube (PSI/100 FT) **C = 140**

SIZE	1/2"		5/8"		3/4"		1"		1 1/4"		1 1/2"		2"		2 1/2"		3"	
OD	0.625		0.750		0.875		1.125		1.375		1.625		2.125		2.625		3.125	
ID	0.527		0.652		0.745		0.995		1.245		1.481		1.959		2.435		2.907	
WALL THK.	0.049		0.049		0.065		0.065		0.065		0.072		0.083		0.095		0.109	
FLOW G. P. M.	Velocity FPS	psi Loss	Velocity FPS	psi Loss	Velocity FPS	psi Loss	Velocity FPS	psi Loss	Velocity FPS	psi Loss	Velocity FPS	psi Loss	Velocity FPS	psi Loss	Velocity FPS	psi Loss	Velocity FPS	psi Loss
1	1.45	1.09	0.95	0.39	0.73	0.20	0.41	0.05	0.26	0.02	0.18	0.01	0.10	0.00				
2	2.93	3.94	1.91	1.40	1.47	0.73	0.82	0.18	0.52	0.06	0.37	0.03	0.21	0.01				
3	4.40	8.35	2.87	2.974	2.20	1.55	1.23	0.38	0.78	0.13	0.55	0.05	0.31	0.01	0.20	0.00		
4	5.87	14.23	3.83	5.05	2.94	2.64	1.64	0.65	1.05	0.22	0.74	0.09	0.42	0.02	0.27	0.01	0.19	0.00
5	7.34	21.51	4.79	7.64	3.67	3.99	2.06	0.98	1.31	0.33	0.93	0.14	0.53	0.04	0.34	0.01	0.24	0.01
6	8.81	30.15	5.75	10.70	4.41	5.60	2.47	1.37	1.57	0.46	1.11	0.20	0.63	0.05	0.41	0.02	0.28	0.01
7	10.28	40.11	6.71	14.24	5.14	7.44	2.88	1.82	1.84	0.61	1.30	0.26	0.74	0.07	0.48	0.02	0.33	0.01
8	11.75	51.37	7.67	18.24	5.88	9.53	3.29	2.33	2.10	0.78	1.48	0.34	0.85	0.09	0.55	0.03	0.38	0.01
9	13.22	63.89	8.63	22.68	6.61	11.86	3.70	2.90	2.36	0.97	1.67	0.42	0.95	0.11	0.61	0.04	0.43	0.02
10	14.69	77.66	9.59	27.57	7.35	14.41	4.12	3.53	2.63	1.18	1.86	0.51	1.06	0.13	0.68	0.05	0.48	0.02
11	16.15	92.65	10.55	32.89	8.08	17.19	4.53	4.21	2.89	1.41	2.04	0.61	1.16	0.16	0.75	0.05	0.53	0.02
12	17.62	108.85	11.51	38.64	8.82	20.20	4.94	4.94	3.15	1.66	2.23	0.71	1.27	0.18	0.82	0.06	0.57	0.03
14			13.43	51.41	10.29	26.87	5.76	6.57	3.68	2.21	2.60	0.95	1.48	0.24	0.95	0.08	0.67	0.04
16			15.35	65.83	11.76	34.41	6.59	8.42	4.21	2.83	2.97	1.22	1.70	0.31	1.10	0.11	0.77	0.05
18			17.27	81.88	13.23	42.80	7.41	10.47	4.73	3.52	3.34	1.51	1.91	0.39	1.23	0.13	0.86	0.06
20			19.19	99.53	14.70	52.02	8.24	12.73	5.26	4.28	3.72	1.84	2.12	0.47	1.37	0.16	0.96	0.07
22					16.17	62.06	9.06	15.18	5.79	5.10	4.09	2.19	2.33	0.56	1.51	0.20	1.06	0.08
24					17.64	72.92	9.89	17.84	6.31	5.99	4.46	2.58	2.55	0.66	1.65	0.23	1.15	0.10
26					19.11	84.57	10.71	20.69	6.84	6.95	4.83	2.99	2.76	0.77	1.78	0.27	1.25	0.11
28							11.53	23.73	7.37	7.98	5.20	3.43	2.97	0.88	1.92	0.30	1.35	0.13
30							12.36	26.97	7.89	9.06	5.58	3.89	3.18	1.00	2.06	0.35	1.44	0.15
35							14.42	35.88	9.21	12.06	6.51	5.18	3.72	1.33	2.40	0.46	1.68	0.19
40							16.48	45.95	10.52	15.44	7.44	6.63	4.25	1.70	2.75	0.59	1.93	0.25
45							18.54	57.15	11.84	19.20	8.37	8.25	4.78	2.12	3.00	0.73	2.17	0.31
50									13.16	23.34	9.30	10.03	5.31	2.57	3.44	0.89	2.41	0.38
55									14.47	27.85	10.23	11.97	5.84	3.07	3.78	1.06	2.65	0.45
60									15.79	32.71	11.16	14.06	6.37	3.60	4.12	1.25	2.89	0.53
65									17.10	37.94	12.09	16.31	6.91	4.18	4.47	1.45	3.13	0.61
70									18.42	43.52	13.02	18.70	7.44	4.80	4.81	1.66	3.37	0.70
75									19.74	49.45	13.95	21.25	7.97	5.45	5.16	1.89	3.62	0.80
80											14.88	23.95	8.50	6.14	5.50	2.13	3.86	0.90
85											15.81	26.80	9.03	6.87	5.84	2.38	4.10	1.01
90											16.74	29.79	9.56	7.64	6.19	2.65	4.34	1.12
95											17.67	32.93	10.09	8.44	6.53	2.93	4.58	1.24
100											18.60	36.21	10.63	9.28	6.88	3.22	4.82	1.36
110													11.69	11.08	7.56	3.84	5.31	1.62
120													12.75	13.01	8.25	4.52	5.79	1.91
130													13.82	15.09	8.94	5.24	6.27	2.21
140													14.88	17.31	9.63	6.01	6.75	2.54
150													15.94	19.67	10.32	6.83	7.24	2.88
160													17.01	22.17	11.00	7.69	7.72	3.25
170													18.07	24.81	11.69	8.61	8.20	3.64
180													19.13	27.58	12.38	9.57	8.69	4.04
190															13.07	10.58	9.17	4.47
200															13.76	11.63	9.65	4.91
225															15.48	14.47	10.86	6.11
250															17.20	17.58	12.07	7.43
275															18.92	20.98	13.27	8.86
300																	14.48	10.41
325																	15.69	12.07
350																	16.89	13.85
375																	18.10	15.73
400																	19.31	17.73
425																		
450																		
475																		
500																		
550																		
600																		

Note: Shaded areas of the chart indicate velocities over 7 feet per second (FPS). Use with caution.

# Charts

## Polyethylene (PE) SDR-Pressure Rated Tube

**SIZES:** 1/2" – 6" **FLOW:** 1 – 600 GPM **PSI LOSS:** Per 100' of tube (PSI/100 FT) **C = 140** (2306, 3206, 3306) SDR 7, 9, 11.5, 15

SIZE	1/2"		3/4"		1"		1 1/4"		1 1/2"		2"		2 1/2"		3"		4"		6"	
ID	0.622		0.824		1.049		1.380		1.610		2.067		2.469		3.068		4.026		6.065	
FLOW G. P. M.	Velocity FPS	psi Loss	Velocity FPS	psi Loss	Velocity FPS	psi Loss	Velocity FPS	psi Loss	Velocity FPS	psi Loss	Velocity FPS	psi Loss	Velocity FPS	psi Loss	Velocity FPS	psi Loss	Velocity FPS	psi Loss	Velocity FPS	psi Loss
1	1.05	0.49	0.60	0.12	0.37	0.04	0.21	0.01	0.15	0.00	0.09	0.00								
2	2.10	1.76	1.20	0.45	0.74	0.14	0.42	0.04	0.31	0.02	0.19	0.01								
3	3.16	3.73	1.80	0.95	1.11	0.29	0.64	0.08	0.47	0.04	0.28	0.01	0.20	0.00						
4	4.21	6.35	2.40	1.62	1.48	0.50	0.85	0.13	0.62	0.06	0.38	0.02	0.26	0.01						
5	5.27	9.60	3.00	2.44	1.85	0.76	1.07	0.20	0.78	0.09	0.47	0.03	0.33	0.01	0.21	0.00				
6	6.32	13.46	3.60	3.43	2.22	1.06	1.28	0.28	0.94	0.13	0.57	0.04	0.40	0.02	0.26	0.01				
7	7.38	17.91	4.20	4.56	2.59	1.41	1.49	0.37	1.10	0.18	0.66	0.05	0.46	0.02	0.30	0.01				
8	8.43	22.93	4.80	5.84	2.96	1.80	1.71	0.474	1.25	0.22	0.76	0.07	0.53	0.03	0.34	0.03				
9	9.49	28.52	5.40	7.26	3.33	2.24	1.92	0.59	1.41	0.28	0.85	0.08	0.60	0.03	0.39	0.01				
10	10.54	34.67	6.00	8.82	3.70	2.73	2.14	0.72	1.57	0.34	0.95	0.10	0.66	0.04	0.43	0.01				
11	11.60	41.36	6.60	10.53	4.07	3.25	2.35	0.86	1.73	0.40	1.05	0.12	0.73	0.05	0.47	0.02	0.27	0.00		
12	12.65	48.60	7.21	12.37	4.44	3.82	2.57	1.01	1.88	0.48	1.14	0.14	0.80	0.06	0.52	0.02	0.30	0.01		
14	14.76	64.65	8.41	16.46	5.19	5.08	2.99	1.34	2.20	0.63	1.33	0.19	0.93	0.08	0.60	0.03	0.35	0.01		
16	16.87	82.79	9.61	21.07	5.93	6.51	3.42	1.71	2.51	0.81	1.52	0.24	1.07	0.10	0.69	0.04	0.40	0.01		
18	18.89	102.97	10.81	26.21	6.67	8.10	3.85	2.13	2.83	1.01	1.71	0.30	1.20	0.13	0.78	0.04	0.45	0.01		
20			12.01	31.86	7.41	9.84	4.28	2.59	3.14	1.22	1.90	0.36	1.33	0.15	0.86	0.05	0.50	0.01		
22			13.21	38.01	8.15	11.74	4.71	3.09	3.46	1.46	2.10	0.43	1.47	0.18	0.95	0.06	0.55	0.02		
24			14.42	44.65	8.89	13.79	5.14	3.63	3.77	1.72	2.29	0.51	1.60	0.21	1.04	0.07	0.60	0.02		
26			15.62	41.79	9.64	16.00	5.57	4.21	4.09	1.99	2.48	0.59	1.74	0.25	1.12	0.09	0.65	0.02		
28			16.82	59.41	10.38	18.35	5.99	4.83	4.40	2.28	2.67	0.68	1.87	0.29	1.21	0.10	0.70	0.03		
30			18.02	67.50	11.12	20.85	6.42	5.49	4.72	2.59	2.86	0.77	2.00	0.32	1.30	0.11	0.75	0.03	0.33	0.00
35					12.97	27.74	7.49	7.31	5.50	3.45	3.34	1.02	2.34	0.43	1.51	0.15	0.88	0.04	0.38	0.01
40					14.83	35.53	8.56	9.36	6.29	4.42	3.81	1.31	2.67	0.55	1.73	0.19	1.00	0.05	0.44	0.01
45					16.68	44.19	9.64	11.64	7.08	5.50	4.29	1.63	3.01	0.69	1.95	0.24	1.13	0.06	0.49	0.01
50					18.53	53.71	10.71	14.14	7.87	6.68	4.77	1.98	3.34	0.83	2.16	0.29	1.25	0.08	0.55	0.01
55							11.78	16.87	8.65	7.97	5.25	2.36	3.68	1.00	2.38	0.35	1.38	0.09	0.61	0.01
60							12.85	19.82	9.44	9.36	5.72	2.78	4.01	1.17	2.60	0.41	1.51	0.11	0.66	0.01
65							13.92	22.99	10.23	10.86	6.20	3.22	4.35	1.36	2.81	0.47	1.63	0.13	0.72	0.02
70							14.99	26.37	11.01	12.46	6.68	3.69	4.68	1.56	3.03	0.54	1.76	0.14	0.77	0.02
75							16.06	29.97	11.80	14.16	7.16	4.20	5.01	1.77	3.25	0.61	1.88	0.16	0.83	0.02
80							17.13	33.77	12.59	15.95	7.63	4.73	5.35	1.99	3.46	0.69	2.01	0.18	0.88	0.03
85							18.21	37.79	13.37	17.85	8.11	5.29	5.68	2.23	3.68	0.77	2.13	0.21	0.94	0.03
90							19.28	42.01	14.16	19.84	8.59	5.88	6.02	2.48	3.90	0.86	2.26	0.23	0.99	0.03
95							14.95	21.93	9.07	6.50	6.35	2.74	4.11	0.95	2.39	0.25	1.05	0.03		
100									15.74	24.12	9.54	7.15	6.69	3.01	4.33	1.05	2.51	0.28	1.10	0.04
110									17.31	28.77	10.50	8.53	7.36	3.59	4.76	1.25	2.76	0.33	1.22	0.05
120									18.88	33.80	11.45	10.02	8.03	4.22	5.20	1.47	3.02	0.39	1.33	0.05
130											12.41	11.62	8.70	4.90	5.63	1.70	3.27	0.45	1.44	0.06
140											13.36	13.33	9.37	5.62	6.06	1.95	3.52	0.52	1.55	0.07
150											14.32	15.15	10.03	6.38	6.50	2.22	3.77	0.59	1.66	0.08
160											15.27	17.08	10.70	7.19	6.93	2.50	4.02	0.67	1.77	0.09
170											16.23	19.11	11.37	8.05	7.36	2.80	4.27	0.75	1.88	0.10
180											17.18	21.24	12.04	8.95	7.08	3.11	4.53	0.83	1.99	0.11
190											18.14	23.48	12.71	9.89	8.23	3.44	4.78	0.92	2.10	0.12
200											19.09	25.81	13.38	10.87	8.66	3.78	5.03	1.01	2.21	0.14
225													15.05	13.52	9.75	4.70	5.66	1.25	2.49	0.17
250													16.73	16.44	10.83	5.71	6.29	1.52	2.77	0.21
275													18.40	19.61	11.92	6.82	6.92	1.82	3.05	0.25
300															13.00	8.01	7.55	2.13	3.32	0.29
325															14.08	9.29	8.18	2.48	3.60	0.34
350															15.17	10.65	8.81	2.84	3.88	0.39
375															16.25	12.10	9.43	3.23	4.15	0.44
400															17.33	13.64	10.06	3.64	4.43	0.50
425															18.42	15.26	10.69	4.07	4.71	0.55
450															19.50	16.97	11.32	4.52	4.99	0.62
475																	11.95	5.00	5.26	0.68
500																	12.58	5.50	5.54	0.75
550																	13.84	6.56	6.10	0.89
600																	15.10	7.70	6.65	1.05

Note: Shaded areas of the chart indicate velocities over 5 feet per second (FPS). Use with caution.





# Warranty

## Limited Product Warranty, Professional Products

K-Rain® **professional** line of products, products purchased at authorized K-Rain distributorships or online, carry a limited warranty from the date of manufacture as stated in the specified period of time on the opposite page. During this period, K-Rain will repair or replace (at the option of K-Rain) the product or any part if the product is found to be defective as to workmanship or material.

This warranty does not extend to damage to a K-Rain® product resulting from misuse, neglect or abuse, normal wear and tear, or accident, to exterior appearance or color or due to improper installation.

**This warranty extends only to an original user of a K-Rain® product.**

IN NO EVENT SHALL K-RAIN® BE LIABLE FOR INCIDENTAL OR CONSEQUENTIAL DAMAGES. ALL IMPLIED WARRANTIES ARE LIMITED IN DURATION TO THREE YEARS FOLLOWING DATE OF MANUFACTURE UNLESS INDICATED OTHERWISE.

Some U.S. states do not permit the exclusion or limitation of incidental or consequential damages or of implied warranties. Therefore, the above exclusions or limitations may not apply to you. If a defect arises in a K-Rain® product within the warranty period, you should promptly contact your K-Rain® installer, distributor or K-RAIN® MANUFACTURING CORPORATION.

This warranty gives you specific legal rights, and you may also have other rights which vary from state to state. If you have any questions concerning the warranty or its application, please contact K-Rain®.



<b>3 YEARS</b>	<b>Controllers</b>	SiteMaster
		Pro EX 2.0
		PRO-LC
		RPST™46
		K-Rain BLUE®
		Controller Accessories
	<b>Rain Sensors</b>	Hardwired Rain Sensor
		Hardwired Rain/Freeze Sensor
		Wireless Rain Sensors
		Wireless Rain/Freeze Sensors
		Universal Wireless Rain/Freeze Sensors
	<b>Rotary Nozzles</b>	Rotary Nozzle Series
		Fully Adjustable Rotary Nozzles
	<b>Drip Irrigation</b>	Dripline
		Drip Fittings
		Drip Control Zone Kits
		Pressure Regulators
	<b>Single Station Controllers</b>	2100 Single Station Controllers
		2200 Short Duration Single Station Controllers
		2500 Rain Switch Ready Controllers
<b>Pump Start Relays</b>	Pump Start Relays	

<b>7 YEARS</b>	<b>Rotors</b>	MiniPro®
		RPST™ 50
		RPST™ 75
		RPST™ 75i
		RPST™ Select
		ProPlus®
		SuperPro®
		ProSport®
		Rotor Accessories
	<b>Sprays</b>	Pro-S™
		NP Sprays
		K-Sprays
		Spray Accessories
	<b>Nozzles</b>	KV Nozzles
		KVF Nozzles
		Fixed Pattern Nozzles
	<b>Bubblers</b>	Bubblers
	<b>Valves</b>	ProSeries 100
		ProSeries 150
		ProSeries 200
		Valve Accessories
	<b>Indexing Valves</b>	4000 Series
		6000 Series



K-Rain® Manufacturing Corp.  
1640 Australian Avenue  
Riviera Beach, FL 33404 USA  
561.844.1002  
Fax: 561.842.9493  
1.800.735.7246

© K-Rain Manufacturing Corporation  
AN ISO 9001 CERTIFIED COMPANY

[www.krain.com](http://www.krain.com)

Follow us on social media:

