



SportsTurf

IRRIGATION

2026 CATALOG



800-492-8378

WWW.SPORTSTURFIRRIGATION.COM

"SPRINKLERS SO PROFESSIONALLY REBUILT...THEY OPERATE LIKE BRAND NEW"

WHAT WE DO BEST

- ✓ OFFER cost-saving “Aftermarket” options for your irrigation budget: valves, controllers, boards, transformers and more.
- ✓ REPAIR RAIN BIRD® and TORO® sprinklers — send yours to us for repair.
- ✓ PROVIDE a fully-funded UPS® label to send your sprinklers and parts in for repair.
- ✓ SELL fully-reconditioned RAIN BIRD® and TORO® sprinklers. (1-year warranty)
- ✓ STOCK a huge inventory of current and hard-to-find parts.
- ✓ BUY your old irrigation system or sprinklers and pay for the freight to ship to us.



REBUILT CONVERSION ASSEMBLIES & COMPLETE SPRINKLERS

1" INLET SPRINKLERS or 1½" INLET SPRINKLERS



CONVERSION

**PART CIRCLE
CONVERSIONS &
DRIVE MOTORS
CAN BE REPAIRED!**

\$44



COMPLETE

1" FULL CIRCLE CONVERSION ASSEMBLIES

Part Number	Description	Price
89-1982	734 Conversion Assy	\$86.00
102-2530	834S Conversion Assy	\$98.00
TO DT34	DT34 Conversion Assy	\$98.00
102-3212	864 Conversion Assy	\$99.00

1½" FULL CIRCLE CONVERSION ASSEMBLIES

Part Number	Description	Price
9-3901	674 Conversion Assy	\$88.00
89-4359	754 Conversion Assy	\$92.00
102-2532	854S Conversion Assy	\$106.00
TO DT54	DT54 Conversion Assy	\$106.00

1" PART CIRCLE CONVERSION ASSEMBLIES

Part Number	Description	Price
89-7015	765 Conversion Assy	\$99.00
102-5391	835S Conversion Assy	\$118.00
TO DT35	DT35 Conversion Assy	\$118.00
102-2550	865 Conversion Assy	\$110.00
Repair	Part Circle Conversion Assy	\$44.00

1½" PART CIRCLE CONVERSION ASSEMBLIES

Part Number	Description	Price
89-6998	785 Conversion Assy	\$104.00
102-5393	855S Conversion Assy	\$129.00
TO DT55	DT55 Conversion Assy	\$129.00
102-2552	885S Conversion Assy	\$118.00
Repair	Part Circle Conversion Assy	\$44.00

WE DO IT ALL! REBUILT CONVERSION ASSEMBLIES OR COMPLETE SPRINKLERS

REBUILT 1" COMPLETE SPRINKLERS



DT 34 VIH	\$180.00
DT 35 VIH	\$190.00
734 HYD/COM	\$110.00
734 VIH	\$138.00
765 HYD/COM	\$120.00
765 VIH	\$162.00
834 VIH	\$180.00
835 VIH	\$190.00

REBUILT 1½" COMPLETE SPRINKLERS



DT 54 VIH	\$189.00
DT 55 VIH	\$204.00
674 HYD/COM	\$125.00
674 VIH	\$155.00
754 HYD/COM	\$126.00
754 VIH	\$175.00
785 HYD/COM	\$140.00
785 VIH	\$184.00
854 VIH	\$189.00
855 VIH	\$204.00

Subject to Availability

VALVES & PILOT VALVES



SPORTSTURF IRRIGATION EXCLUSIVES



1" BOX OF 6: \$264.00
\$44.00 each

STI TO 10048 Short Pin - 700 Series
STI TO 10024 Long Pin - 800 Series



**PROVEN
COST SAVERS**



1 1/2" BOX OF 6: \$378.00
\$63.00 each

STI TO 15003

AFTERMARKET 1" & 1 1/2" ELECTRIC BOTTOM/FOOT VALVE REPLACEMENTS

BOTTOM/FOOT VALVES 1" & 1 1/2" (REBUILT)

1" 700 / 800 SERIES



700 Series		
Part Number	Description	Price
89-1048	Electric	\$49.00
89-1047	Check-O	\$26.00
89-1046	Hydraulic	\$29.00
89-1048-R*	Repair	\$30.00
800 Series		
102-0624	Electric	\$49.00
102-0624-R*	Repair	\$30.00

1 1/2" 700/800 SERIES



700/800 Series		
Part Number	Description	Price
102-4003	Electric	\$69.00
89-1037	Check-O	\$42.00
89-1036	Hydraulic	\$45.00
102-4003-R*	Repair	\$33.00

* Cylinder (Cap) Additional Part Charge on Valve Repair

Part Number	Description	Price
102-5975	Adjustable NO Solenoid	\$39.00
102-5178	Adjustable WITH Solenoid	\$65.00
89-1000	Pilot Valve NO Solenoid	\$33.00
89-0009	Pilot Valve WITH Solenoid	\$56.00
89-1000-R	Pilot Valve - Repair	\$20.00
9-1876	Tubing 1/2" x 1 1/2"	\$3.80
360-0220	O-Ring Body Assy	\$.70
102-0343	Selector Cam Black	\$4.25

PILOT VALVES & PILOT VALVE PARTS (REBUILT)



Adj Pilot Valve with Solenoid



Pilot Valve with Solenoid

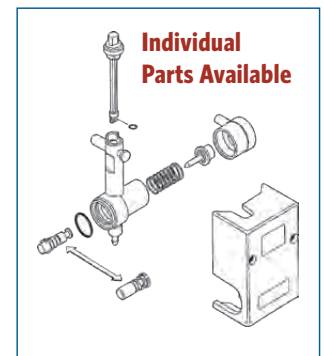

Individual Parts Available

1" & 1½" REBUILT SPRINKLER PARTS

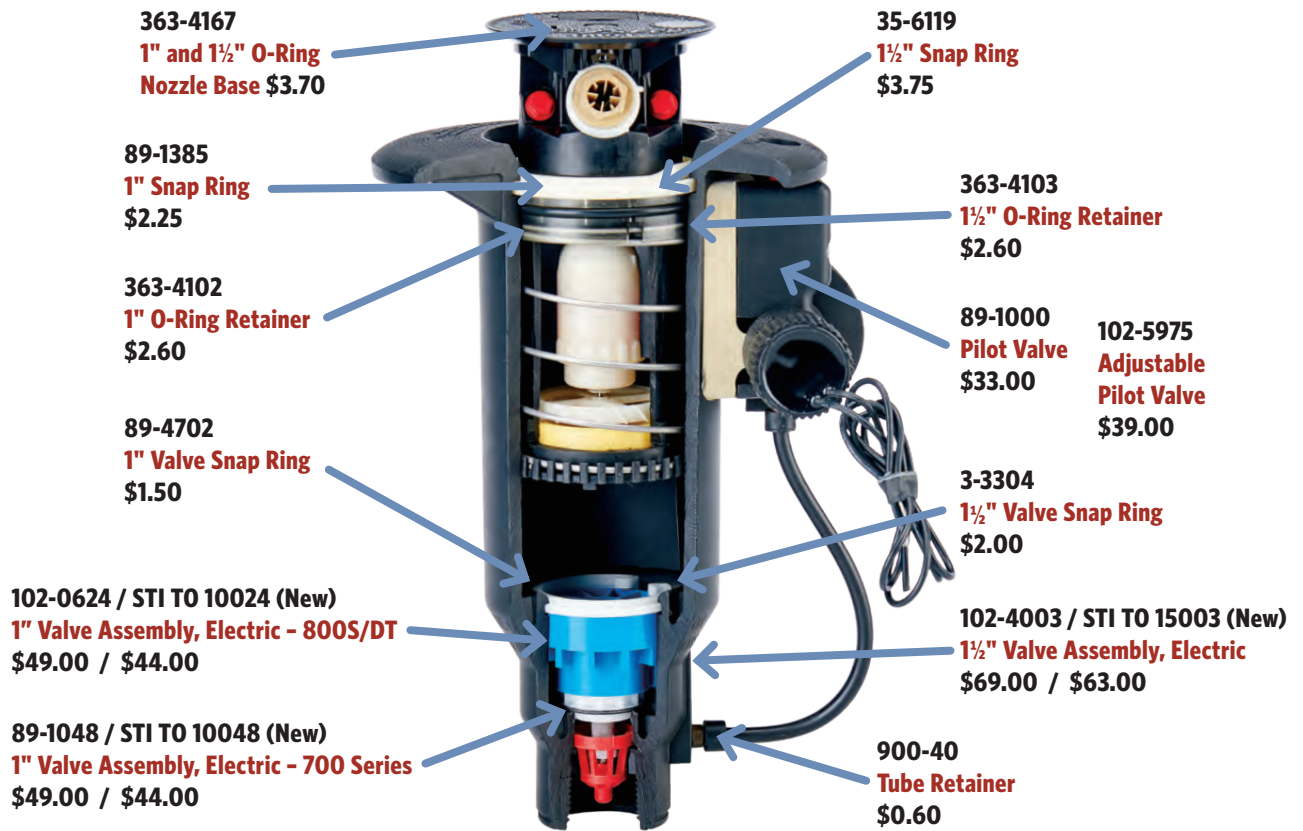

1" CASE PARTS

Part Number	Description	Price
35-9421	700 Series 1" Elec Case Only NO PV, Valve, Solenoid	\$53.00
89-4868	700 Series 1" Elec Case WITH PV, Valve, Solenoid	\$105.00
102-1090	800 Series 1" Elec Case Only - NO PV, Valve, Solenoid	\$64.00
102-1090-99	800 Series 1" Elec Case Assy WITH PV, Valve, Solenoid	\$137.00
35-9418	700 Series 1" Hydraulic Case Only	\$53.00
89-1385	Snap Ring - Upper to Hold Sprinkler	\$2.25
89-4702	Snap Ring - Lower to Hold Valve	\$1.50

1½" CASE PARTS

Part Number	Description	Price
3-3389	700 Series 1½" Elec Case Only NO PV, Valve, Solenoid	\$65.00
89-1016	700 Series 1½" Elec Case Assy WITH PV, Valve, Solenoid	\$112.00
102-1149	800 Series 1½" Elec Case Only NO PV, Valve, Solenoid	\$70.00
102-1149-99	800 Series 1½" Elec Case Assy WITH PV, Valve, Solenoid	\$145.00
3-3343	700 Series 1½" Hydraulic Case Only	\$60.00
35-6119	Snap Ring - Upper to Hold Sprinkler	\$3.75
3-3304	Snap Ring - Lower to Hold Valve	\$2.00



O-RINGS, SOLENOIDS & TOOLS

THESE ALWAYS NEED TO BE REPLACED!
NO BAG QUANTITY REQUIRED
CHANGING O-RINGS JUST MAKES SENSE!

363-4167
 Nozzle Base for
 1" Inlet & 1/2"
 Inlet Sprinklers
 \$3.70



1/2"

363-4102
 Retainer for 1" Inlet
 Sprinklers
 \$2.60

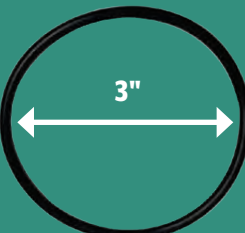

3"

363-4103
 Retainer for 1 1/2"
 Inlet Sprinklers \$2.60



3 1/4"

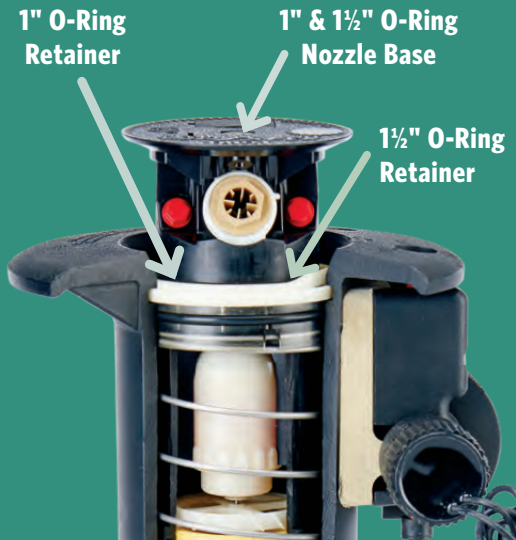

1" O-Ring Retainer 1" & 1/2" O-Ring Nozzle Base
 1 1/2" O-Ring Retainer



995-82
Arc Adjustment Tool

Check Out Solenoids from SportsTurf Irrigation



STI 118-0248-99
\$34.00



UH A-SKTRB
SuperKey XL™



Includes:
HoseTap™
1" MHT Brass Swivel
and 3/4" Adapter



UH HN-T100S
1" Inlet
UH HN-T150S
1 1/2" Inlet



BOARD TRONICS

NEVER USED, NEVER REPAIRED!

Manufactured by BoardTronics, these brand new SuperParts™ faceplates and boards offer premium parts without the premium price tag.



**SuperParts™ 72-Station
Timing Mechanism Par+ES**
\$440.99



**SuperParts™ 48-Station
Timing Mechanism Par+**
\$440.99

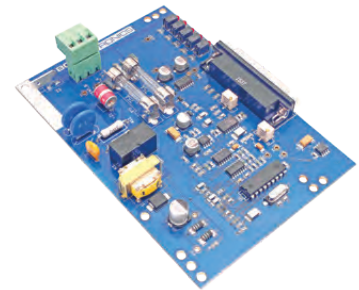

**SuperParts™ Standard
Modem Network 8000/VP®**
\$264.99

Instead of waiting for repairs, get fast turn-around times with these aftermarket solutions for Rain Bird® and Toro® Controllers.

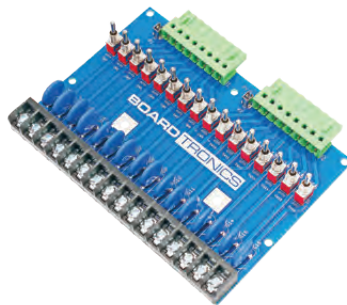

**SuperParts™ 16-Station Switch
& Surge Board Network VP®**
\$242.99



**SuperParts™ Timing
Mechanism for Network VP®**
\$342.99

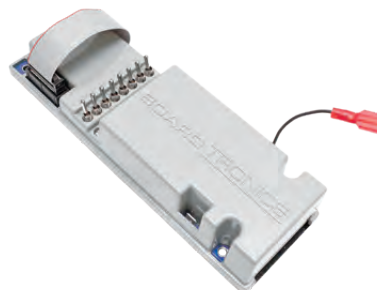

**SuperParts™ Output Station Module
(OSM) MSC+/PAR+/PAR+ES**
\$269.99



**SuperParts™ 2-Wire Comm Board
MSC+/PAR+/PAR+ES**
\$269.99

TURF PRODUCTS



**Rain Bird® Quick Couplers
Valves, Swivels & Keys
3/4" - 1½"**

RAIN BIRD® QUICK COUPLER REFERENCE

Order	Top of QC	Bottom of QC
#33	1/2"	3/4"
#44	3/4"	1"
#5	1"	1"
#7	1½"	1½"

QUICK COUPLER KEY REFERENCE

Order	Top of Key	Bottom of Key
33K	3/4"	1/2"
44K	1"	3/4"
55K	1"	1"
7K	1½"	1½"



**VersaLid™
Universal Replacement Lid
6", 7" & 10" Round Valve Box**

4 Easy Steps to Build Your Specific Westlake Swing Joint

STEP 1: SPECIFY A BODY DIAMETER BY NUMBER

First Digit	Diameter Size
1	1"
2	1¼"
3	1½"

STEP 2: SPECIFY AN INLET BY NUMBER (PIPE IN GROUND)

Second Digit	Inlet Style
1	Socket
2	Spigot (short)
3	Male Thread (MIPT)
4	Male ACME
7	Long Spigot (4" Long)

STEP 3: SPECIFY OUTLET BY NUMBER (SPRINKLER TO THREAD ONTO)

Third Digit	Outlet Style
1	Socket
2	MIPT (available in 1", 1¼" and 1½" diameter)
3	Enlarging MIPT (available in 1", 1¼" and 1½" diameter)
4	MIPT Special (available in 1" and 1¼" diameter)
8	Increasing ACME (available in 1½" diameter)
0	ACME (available in 1", 1¼" and 1½" diameter)
A	ACME Special (available in 1¼" diameter)

STEP 4: SPECIFY LAY LENGTH

Last Three Digits	Lay Length	
-208	8"	Standard Sizes
-212	12"	
-218	18"	
		Call for Custom Sizes!

EXAMPLE

Step 1
1¼" Diameter

Step 2
MIPT Inlet

Step 3
1¼" x 1½"
MIPT Outlet

Lay Length

Step 4
18" Lay Length
Unitized Swing Joint

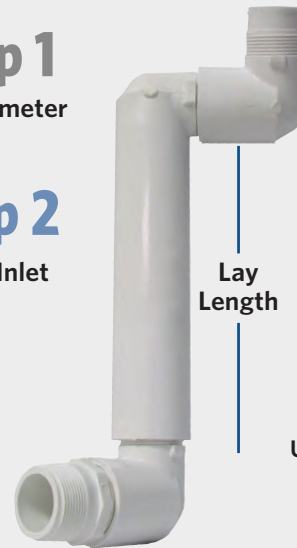

If you need a 1¼" Swing Joint with an MIPT inlet and a 1½" Increasing MIPT outlet (18" Lay Length), your part number would be **233-218**.
Also see LASCOFITTINGS.COM for online configurator.

**3M DBR/Y
Splice Kit**

Box of 100
or Purchase
Individually



COMPARE K-RAIN® TO OTHER PGP STYLE ROTORS High Performance, Low Maintenance



This patented "Easy Arc Setting" just made your irrigator's life a whole lot easier!

7-Year Warranty

Available on ALL models of K-Rain® rotors.



K-RAIN®	MINIPRO 6" 20/Case	SUPERPRO 20/Case	RPS75i 20/Case	PROSPORT 12/Case
INLET	1/2"	3/4"	3/4"	1"
COVERAGE	40° - 360°	40° - 360°	40° - 360°	40° - 360°
FLOW RANGE (GPM)	.8 - 3.8	.8 - 11.1	.9 - 9.7	5.1 - 32.5
PRESSURE (PSI)	20 - 70	20 - 70	20 - 70	40 - 90
RADIUS	18' - 33'	26' - 46'	26' - 48'	43' - 77'
RECLAIMED WATER	YES	YES	YES	YES
WHAT YOU SHOULD KNOW	Perfect for landscape areas and for replacing fixed sprays	Best 3/4" Option Reduce distance & flow rate proportionately	Direct replacement for Hunter® PGP® & PGP® Ultra®	Great Block Type System replacement

★ CLEAN UP AROUND ★ YOUR HEADS



TAS Trimmer Sprinkler
Head Trimmer 3 3/4" - 10"

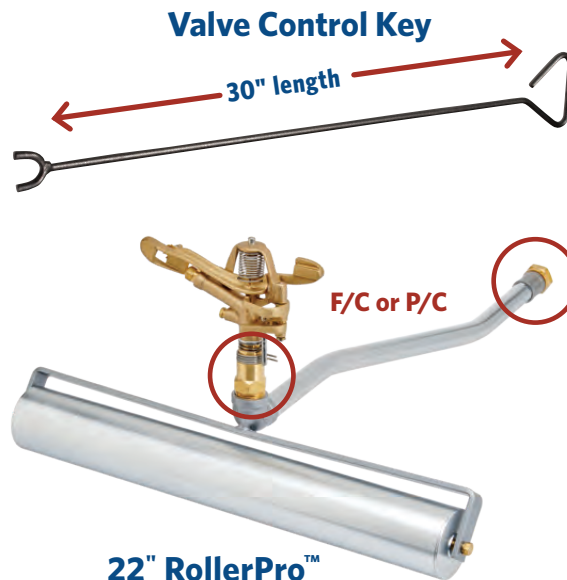

22" RollerPro™
Works with both 1" and 3/4" hoses using the included adapters and full circle and part circle sprinklers.
(sprinkler sold separately)

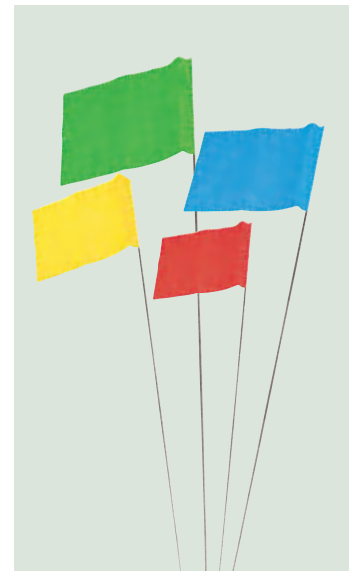

Marking Flags
(Bundle of 100)

REPAIR COUPLINGS & ACCESSORIES

KwikRepair™ WE LOVE THIS PRODUCT & YOU WILL TOO!

1

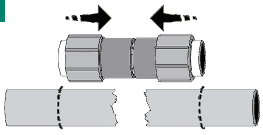

Use fitting as a template to ensure exact fit.

2

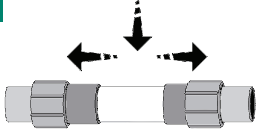

Install fitting and dry fit couplers.

3

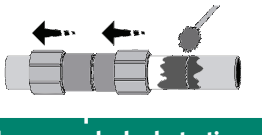

Slide one coupler back at a time. Prime and glue both fitting and body pipe.

4

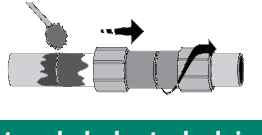

Twist coupler back onto glued pipe until arrows on fitting are fully exposed. Hold until set.

A Permanent Solvent Weld Repair Fitting



KwikRepair Coupling
1/2" - 4"



KwikRepair Tee
1/2" - 2"

Other Coupler Options



Harco Knock On Repair Coupling
1 1/2" - 6"



NDS® Compression Coupling
1" - 3"



Slip Fix Telescopic Coupling
1/2" - 2"

TurboTrim™ Head Trimmer

Comfortable Rubber Handle Grips

Super Heavy Duty Steel Construction & Powder Coated Finish

Forward and Reverse Drive Ratchet Mechanism

7", 8" or 11"

*T Handle and Blades Sold Separately

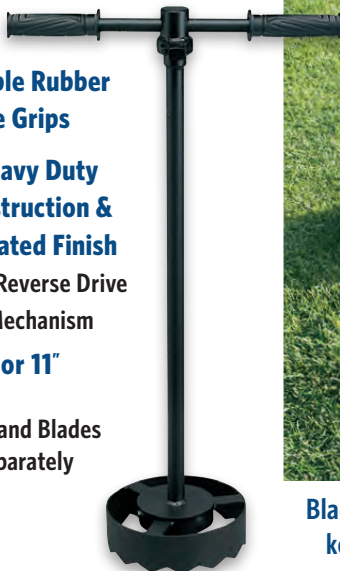

Blade Depth Stopper keeps wires from getting cut!

PowerTrim™ Pro Series

Designed to Fit Most Major Straight Shaft Power Trimmer Bands 7", 8" or 11"



A Blade Adapter Kit is needed to mount any blade.

ULTRAMAX™ HOSES

Customizable Sizes Available



UltraMax™ Featherweight

1200 psi Burst / 300 psi Operating
 $\frac{3}{4}$ " - 9 lbs, 1" = 15 lbs (per 100 ft)

- Extremely lightweight with high pressure rating
- Smooth outer fabric slides over turf without scuffing



UltraMax™ Blue

1200 psi Burst / 300 psi Operating
 $\frac{3}{4}$ " = 27 lbs, 1" = 43 lbs (per 100 ft)

- Best combination of weight, durability, flexibility, pressure strength & flow rate
- Soft & flexible - won't scuff greens



UltraMax™ Red

800 psi Burst / 200 psi Operating
 $\frac{3}{4}$ " = 38 lbs, 1" = 59 lbs (per 100 ft)

- Ultimate choice for long life under heavy use
- Kink, tangle & weather resistant



UltraMax™ Green

800 psi Burst / 200 psi Operating
 $\frac{3}{4}$ " = 28 lbs, 1" = 38 lbs (per 100 ft)

- Lightweight with a high burst pressure rating
- Smooth outer texture won't scuff greens



UltraMax™ Clear

600 psi Burst / 150 psi Operating
 $\frac{3}{4}$ " = 20 lbs, 1" = 32 lbs (per 100 ft)

- Lightweight & economical
- Ideal for light to medium commercial duty

Magnum™ Stinger

The All PRESSURE NOZZLE

The Magnum™ Stinger nozzle is an incredibly smooth operating nozzle, making it ideal for low pressure or low flow rate situations.



MAGNUM™ ULTRAMAX NOZZLES

MAGNUM™ UltraMAX Multi-BLAST™ 4 nozzles in 1



Turbo Shift (12-43 GPM) Premium Plus Pro Series 3/4" & 1"



Full Throttle (15-40 GPM) Premium Plus Pro Series 3/4" & 1"



Turbo Shift (12-43 GPM) Premium Pro Series 3/4" & 1"



Full Throttle (15-40 GPM) Premium Pro Series 3/4" & 1"



RainPro™ UltraMax Shower Nozzle (40+ GPM)



Hunter® SpotShot Spray Nozzle (35 GPM) 3/4" & 1"

Magnum™ Nozzle



CoolPro™ Valve & Nozzle (4-6 GPM)



Precision™ Nozzles



ACCESSORIES

PELLETPRO™ Applicator Gun

For Solid Wetting Agent Tablets



LiquidPro™ Applicator Gun

For Liquid Wetting Agents



Tournament Ready® Plus
with Actosol® Pellets

HOSE CADDIE™ Hose Reel

No more lifting, twisting, or winding up hoses



FEATURES:

- Carries Over 125 ft of 1" or 150 ft of 3/4" Hose
- Quick Coupler Key Holder Mounted to Frame
- Optional Hose Guide Mounts to Reel for Easy Winding
- Includes a 10 ft UltraMax Blue Leader Hose



Twist-Ease™ Kink Eliminator - Never Fight with a Tangled Hose Again!



FEATURES:

- High Quality, High Flow, Brass Swivel that fits between your hose and nozzle
- Simply pull the hose by the nozzle and all twists, kinks and tangles will spin out with the swivel making untangling your hose a breeze!
- Available in 1" NPSH or 3/4" GHT



DRAINBLASTER™ Nozzle

High Pressure Drain Cleaning Nozzle 3/4" & 1"



This unique hose-end, high pressure nozzle guides itself in cleaning out drains, to remove debris with ease. Special feature includes a wire attachment connector for using wire locator to determine drain route.

POWERBLAST™ Super Sweeper

Solid Brass Sweeper Nozzle

FEATURES:

- Solid Machined Brass Construction
- Constant Flow Smooth Operation
- Simple, Reliable, Long Life



HIGH FLOW VALVES AND ADAPTERS



POWERGULP™ Pump

For Professional Water Removal

Pump Specifications:

- Flow Rate - 11 GPM
- Length - 48"
- Weight - 4 lbs (without battery)
- Battery Run Time - Up to 60 Minutes w/ 4 Amp Hr. Battery
- Head Height - 15 ft
- Not For Use on Flammable Liquids
- 18 Volt



**POWER
GULP**

MudGuard™

GULP™ PRO Pumps

Water Removal Pumps 72" or 36" discharge hose



GULP™ PRO Syringe

SUPERINTENDENTS & IRRIGATORS TRUST US



SportsTurf Irrigation has taken us to the next level. We don't have to worry about our irrigation anymore. We can get products when we need them, and it's always top quality.

Superintendent Emry Pensinger, Elephant Rocks Golf Course



800-492-8378

WWW.SPORTSTURFIRRIGATION.COM

SportsTurf Irrigation is an independent service and manufacturing business and is not affiliated with, or authorized as a representative, service provider, or contractor of services by The Toro Company or Rain Bird Corporation. All references to OEM brands, trademarks, model numbers, and/or the display of certain identifying images herein are done solely for the purpose of identification of independent services provided by SportsTurf Irrigation. All trademarks contained herein belong to their respective manufacturers. Pricing terms and conditions are subject to change without notification. Visit our website at www.sportsturfirrigation.com for additional terms and conditions. This catalog and all its content are protected by intellectual property or proprietary rights held solely by Water Utilities Services, Inc. None of the images or copy may be copied or reproduced for commercial use without written approval from Water Utilities Services, Inc.